

Real-Time Windows Target™ 3

User's Guide



MATLAB®
& **SIMULINK®**

How to Contact The MathWorks



www.mathworks.com Web
comp.soft-sys.matlab Newsgroup
www.mathworks.com/contact_TS.html Technical Support



suggest@mathworks.com Product enhancement suggestions
bugs@mathworks.com Bug reports
doc@mathworks.com Documentation error reports
service@mathworks.com Order status, license renewals, passcodes
info@mathworks.com Sales, pricing, and general information



508-647-7000 (Phone)



508-647-7001 (Fax)



The MathWorks, Inc.
3 Apple Hill Drive
Natick, MA 01760-2098

For contact information about worldwide offices, see the MathWorks Web site.

Real-Time Windows Target™ User's Guide

© COPYRIGHT 1999–2010 by The MathWorks, Inc.

The software described in this document is furnished under a license agreement. The software may be used or copied only under the terms of the license agreement. No part of this manual may be photocopied or reproduced in any form without prior written consent from The MathWorks, Inc.

FEDERAL ACQUISITION: This provision applies to all acquisitions of the Program and Documentation by, for, or through the federal government of the United States. By accepting delivery of the Program or Documentation, the government hereby agrees that this software or documentation qualifies as commercial computer software or commercial computer software documentation as such terms are used or defined in FAR 12.212, DFARS Part 227.72, and DFARS 252.227-7014. Accordingly, the terms and conditions of this Agreement and only those rights specified in this Agreement, shall pertain to and govern the use, modification, reproduction, release, performance, display, and disclosure of the Program and Documentation by the federal government (or other entity acquiring for or through the federal government) and shall supersede any conflicting contractual terms or conditions. If this License fails to meet the government's needs or is inconsistent in any respect with federal procurement law, the government agrees to return the Program and Documentation, unused, to The MathWorks, Inc.

Trademarks

MATLAB and Simulink are registered trademarks of The MathWorks, Inc. See www.mathworks.com/trademarks for a list of additional trademarks. Other product or brand names may be trademarks or registered trademarks of their respective holders.

Patents

The MathWorks products are protected by one or more U.S. patents. Please see www.mathworks.com/patents for more information.

Revision History

January 1999	First printing	New for Version 1.0 (Release 11.0)
January 2000	Second printing	Revised for Version 1.5 (Release 11.1+)
September 2000	Third printing	Revised for Version 2.0 (Release R12)
June 2001	Online only	Revised for Version 2.1 (Release R12.1)
July 2002	Online only	Revised for Version 2.2 (Release 13)
June 2004	Fourth printing	Revised for Version 2.5 (Release 14)
October 2004	Fifth printing	Revised for Version 2.5.1 (Release 14SP1)
March 2005	Online only	Revised for Version 2.5.2 (Release 14SP2)
September 2005	Online only	Revised for Version 2.6 (Release 14SP3)
March 2006	Online only	Revised for Version 2.6.1 (Release 2006a)
September 2006	Online only	Revised for Version 2.6.2 (Release 2006b)
March 2007	Online only	Revised for Version 2.7 (Release 2007a)
September 2007	Online only	Revised for Version 3.0 (Release 2007b)
March 2008	Online only	Revised for Version 3.1 (Release 2008a)
October 2008	Online only	Revised for Version 3.2 (Release 2008b)
March 2009	Online only	Revised for Version 3.3 (Release 2009a)
September 2009	Online only	Revised for Version 3.4 (Release 2009b)
March 2010	Online only	Revised for Version 3.5 (Release 2010a)

Getting Started

1

Product Overview	1-2
Using This Guide	1-4
Features	1-5
Real-Time Kernel	1-5
Real-Time Application	1-6
Signal Acquisition and Analysis	1-7
Parameter Tuning	1-8
Hardware Environment	1-10
PC-Compatible Computer	1-10
Input/Output Driver Support	1-10
Software Environment	1-12
Non-Real-Time Simulation	1-12
Real-Time Execution	1-12
Development Process	1-13
System Concepts	1-15
Simulink External Mode	1-15
Data Buffers and Transferring Data	1-16

Installation and Configuration

2

Required Products	2-2
Platform	2-2
The MATLAB Environment	2-2
Simulink Software	2-2

Real-Time Workshop Code Generation Software	2-3
Related Products	2-5
System Requirements	2-6
Platform Requirements	2-6
Hardware Requirements	2-6
Software Requirements	2-6
Real-Time Windows Target Installed Files	2-8
Initial Working Directory	2-10
Working Directory Location Requirement	2-10
Setting the Working Directory from the Desktop Icon	2-10
Setting the Working Directory from the MATLAB Environment	2-10
Real-Time Windows Target Kernel	2-12
About the Kernel	2-12
Installing the Kernel	2-12
Uninstalling the Kernel	2-14
Testing the Installation	2-17
About Installation Testing	2-17
Running the Model rtdvp.mdl	2-17
Displaying Status Information	2-19
Detecting Excessive Sample Rates	2-20
Demo Library	2-21

Basic Procedures

3

Using Simulink Models	3-2
About Simulink Models	3-2
Creating a Model	3-2
Configuring a Model	3-6
Running a Simulation	3-12

Using Real-Time Applications	3-14
About Real-Time Applications	3-14
Entering Simulation Parameters	3-14
Entering Scope Parameters for Signal Tracing	3-17
Creating a Real-Time Application	3-19
Entering Additional Scope Parameters for Signal Tracing	3-20
Running a Real-Time Application	3-23
Running an Application from the Command Line	3-25
Logging Signals to the Base Workspace	3-27
About Signal Logging	3-27
Entering Scope Parameters	3-27
Entering Signal and Triggering Properties	3-29
Plotting Logged Signal Data	3-31
Logging Signals to a Disk Drive	3-34
About Signal Logging	3-34
Entering Scope Parameters	3-34
Entering Signal and Triggering Properties	3-37
Entering Data Archiving Parameters	3-39
Plotting Logged Signal Data	3-41
Tuning Parameters	3-44
About Parameter Tuning	3-44
Changing Model Parameters	3-45

Boards, Blocks, and Drivers

4

Introduction	4-2
Using I/O Boards	4-3
About I/O Boards	4-3
Installing and Configuring I/O Boards and Drivers	4-3
ISA Bus Board	4-7
PCI Bus Board	4-7
PC/104 Board	4-8
Compact PCI Board	4-8

PCMCIA Board	4-9
Using I/O Driver Blocks	4-10
About I/O Driver Blocks	4-10
The Real-Time Windows Target Library	4-10
Output Signals from an I/O Block	4-11
Variations with Channel Selection	4-12
Using Analog I/O Drivers	4-16
About Analog Drivers	4-16
I/O Driver Characteristics	4-16
Normalized Scaling for Analog Inputs	4-17
Using Vector CAN Drivers	4-21

Troubleshooting

5

Introduction	5-2
Building Older Models	5-3
Plots Not Visible in Simulink Scope Block	5-4
Failure to Connect to Target	5-5
Scope Output Delayed or Missing	5-6
S-Functions Using Math Functions	5-7

Custom I/O Driver Blocks

A

Introduction	A-2
I/O Register Access from S-Functions Limitation	A-3
Incompatibility with Win32 API Calls	A-4
Unsupported C Functions	A-5
Supported C Functions	A-6

Examples

B

Simulink Model Examples	B-2
Real-Time Application Examples	B-2
Signal Logging to MATLAB Workspace Examples	B-2
Signal Logging to Disk Drive Examples	B-2
Parameter Tuning Examples	B-3
I/O Board Examples	B-3

Index

Getting Started

- “Product Overview” on page 1-2
- “Using This Guide” on page 1-4
- “Features” on page 1-5
- “Hardware Environment” on page 1-10
- “Software Environment” on page 1-12
- “System Concepts” on page 1-15

Product Overview

Real-Time Windows Target™ rapid prototyping software is a PC solution for prototyping and testing real-time systems. Real-Time Windows Target software uses a single computer as a host and target. On this computer, you use the MATLAB® environment, Simulink® software, and Stateflow® software (optional) to create models using Simulink blocks and Stateflow diagrams.

After creating a model and simulating it using Simulink software in normal mode, you can generate executable code with Real-Time Workshop® code generation software, Stateflow® Coder™ code generation software (optional), and the Open Watcom C/C++ compiler. Then you can run your application in real time with Simulink external mode.

Integration between Simulink external mode and Real-Time Windows Target software allows you to use your Simulink model as a graphical user interface for

- **Signal visualization** — Use the same Simulink Scope blocks that you use to visualize signals during a non-real-time simulation to visualize signals while running a real-time application.
- **Parameter tuning** — Use the Block Parameter dialog boxes to change parameters in your application while it is running in real time.

Note Opening a dialog box for a source block causes Simulink to pause. While Simulink is paused, you can edit the parameter values. You must close the dialog box to have the changes take effect and allow Simulink to continue.

Typical uses for Real-Time Windows Target applications include

- **Real-time control** — Create a prototype of automotive, computer peripheral, and instrumentation control systems.
- **Real-time hardware-in-the-loop simulation** — Create a prototype of controllers connected to a physical plant. For example, the physical plant could be an automotive engine. Create a prototype of a plant connected to

an actual controller. For example, the prototyped plant could be an aircraft engine.

- **Education** — Teach concepts and procedures for modeling, simulating, testing real-time systems, and iterating designs.

Using This Guide

To benefit from this User's Guide, you should be familiar with

- Using Simulink software and Stateflow software to create models as block diagrams, and simulating those models using Simulink software
- The concepts and use of Real-Time Workshop code generation software to create executable code

When using Real-Time Workshop code generation software and Real-Time Windows Target software, you do not need to program in C or other low-level programming languages to create and test real-time systems.

If You Are a New User — Begin with Chapter 1, “Getting Started”. This chapter gives you an overview of Real-Time Windows Target features and the development environment. Next, read and try the examples in Chapter 3, “Basic Procedures”.

If You Are an Experienced User — We suggest you review the sections on signal tracing and signal logging in Chapter 3, “Basic Procedures”. After you are familiar with using Real-Time Windows Target software, read how to add I/O drivers to your Simulink model in Chapter 4, “Boards, Blocks, and Drivers”.

Features

In this section...

“Real-Time Kernel” on page 1-5

“Real-Time Application” on page 1-6

“Signal Acquisition and Analysis” on page 1-7

“Parameter Tuning” on page 1-8

Real-Time Kernel

Real-Time Windows Target software uses a small real-time kernel to ensure that the real-time application runs in real time. The real-time kernel runs at CPU ring zero (privileged or kernel mode) and uses the built-in PC clock as its primary source of time:

- **Timer interrupt** — The kernel intercepts the interrupt from the PC clock before the Windows® operating system receives it. The kernel then uses the interrupt to trigger the execution of the compiled model. As a result, the kernel is able to give the real-time application the highest priority available.

Note This behavior intercepts any calls to the Windows operating system. Consequently, **you cannot use Win32 calls in your C-code S-function.** For more information, see “Incompatibility with Win32 API Calls” on page A-4.

The kernel is provided as a kernel-mode driver. To achieve precise sampling, the kernel reprograms the PC clock to a higher frequency. Because the PC clock is also the primary source of time for the Windows operating system, the kernel sends a timer interrupt to the operating system at the original interrupt rate.

- **Scheduler** — The timer interrupt clocks a simple scheduler that runs the executable. The number of tasks is equal to the number of sampling periods in the model with multitasking mode. With single-tasking mode, there is only one task. The maximum number of tasks is 32, and faster

tasks have higher priorities than slower tasks. For example, a faster task can interrupt a slower task.

During execution, the executable stores data in buffers. Later, the data in these buffers is retrieved by the Scope block. The scheduling, data storing, data transferring, and running the executable all run at CPU ring zero.

- **Communication with hardware** — The kernel interfaces and communicates with I/O hardware using I/O driver blocks, and it checks for proper installation of the I/O board. If the board has been properly installed, the drivers allow your real-time application to run.

You can choose to have a driver block use values equal to voltage, normalize values from 0 to +1, normalize values from -1 to +1, or use the raw integer values from the A/D or D/A conversion press. Drivers also run at CPU ring zero.

- **Simulink external mode** — Communication between Simulink software and the real-time application is through the Simulink external mode interface module. This module talks directly to the real-time kernel, and is used to start the real-time application, change parameters, and retrieve scope data.

Note Opening a dialog box for a source block causes Simulink to pause. While Simulink is paused, you can edit the parameter values. You must close the dialog box to have the changes take effect and allow Simulink to continue.

Real-Time Application

The real-time application runs in real time on your PC computer and has the following characteristics:

- **Compiled code** — Created from the generated C-code using the Open Watcom C/C++ compiler. For your convenience, this compiler is shipped with the Real-Time Windows Target software. No other third-party compiler is needed or can be used.

Note The Real-Time Windows Target software always uses the Open Watcom C/C++ compiler, even if you have specified some other compiler using the `mex -setup` command. Real-Time Windows Target software cannot be configured to use a compiler other than Open Watcom C/C++.

The Open Watcom source code is available under the terms of the Open Watcom License. For more information, visit <http://www.openwatcom.org>.

- **Relation to your Simulink model** — The executable contains a binary form of all Simulink model components, connections between blocks, time dependencies, and variables in the Simulink blocks.
- **Relation to the kernel** — The executable must be loaded and executed directly by the Real-Time Windows Target kernel. It cannot be executed without the kernel.

The kernel runs as a kernel-mode driver, intercepts timer interrupts from the PC clock, maintains clock signals for the Windows operating system, and ensures real-time execution of the real-time application. As a result, both the kernel and the real-time application run at CPU ring zero.

- **Checksum** — The Simulink model and the executable contain a checksum value. The kernel uses this checksum value to determine if the Simulink model structure, at the time of code generation, is consistent with the real-time application structure during execution. This ensures that when you change parameters during an execution, the mapping of Simulink model parameters to the memory locations in the real-time application is correct.

If you make structural changes to your Simulink model, the Simulink checksum value will not match the executable checksum value. You will have to rebuild your executable before you can connect it to your Simulink model.

Signal Acquisition and Analysis

You can acquire, display, and save signals by using Simulink Scope blocks and Simulink external mode. This lets you observe the behavior of your model during a simulation or your application while it runs in real time.

You can acquire signal data while running your real-time applications using

- **Signal Tracing** — Process of acquiring and visualizing signals during a real-time run. It allows you to acquire signal data and visualize it on your computer while the executable is running.
- **Signal Logging** — Process for acquiring signal data during a real-time run. After the run reaches its final time or you manually stop the run, you can plot and analyze the data.

You can save (log) data to variables in the MATLAB workspace or save data to your disk drive with MAT-files.

Signal logging differs from signal tracing. With signal logging you can only look at a signal after a run is finished.

For more information, see “Logging Signals to the Base Workspace” on page 3-27 and “Logging Signals to a Disk Drive” on page 3-34.

Parameter Tuning

Change the parameters in your Simulink model and observe the effect of those changes during a simulation or while running an application in real time.

Simulink external mode — You use Simulink external mode to connect your Simulink block diagram to your real-time application. The block diagram becomes a graphical user interface (GUI) to that executable.

Simulink external mode allows you to change parameters by editing the block diagram while running a simulation in external mode. New parameter values are automatically transferred to the real-time application while it is running.

Note Opening a dialog box for a source block causes Simulink to pause. While Simulink is paused, you can edit the parameter values. You must close the dialog box to have the changes take effect and allow Simulink to continue.

There are different types of model parameters that you can change while running your real-time application. For example, parameters include the amplitude of a gain and the frequency of a sine wave. After you connect your real-time application to your Simulink model, you can change parameters.

You can change these parameters before or while your real-time application is running by using one of the following methods:

- **Block parameters** — Change values in the dialog boxes associated with the Simulink blocks.
- **Block parameters for masked subsystems** — Change values in user-created dialog boxes associated with a subsystem.
- **MATLAB variables** — Create MATLAB variables that represent Simulink block parameters, and then change parameter values by entering the changes through the MATLAB command line.

For more information about parameter tuning, see “Tuning Parameters” on page 3-44.

Hardware Environment

In this section...
“PC-Compatible Computer” on page 1-10
“Input/Output Driver Support” on page 1-10

PC-Compatible Computer

You can use any PC-compatible computer that runs Microsoft® Windows XP 32-bit, or Microsoft Windows Vista™ 32-bit.

Your computer can be a desktop, laptop, or notebook PC.

Input/Output Driver Support

Real-Time Windows Target applications use standard and inexpensive I/O boards for PC-compatible computers. When running your models in real time, Real-Time Windows Target software captures the sampled data from one or more input channels, uses the data as inputs to your block diagram model, immediately processes the data, and sends it back to the outside world through an output channel on your I/O board.

I/O Boards

I/O boards — Real-Time Windows Target software supports a wide range of I/O boards. Some of the capabilities on a board may not be supported by Real-Time Windows Target software. Check Supported I/O Boards on the MathWorks Web site for an updated list of supported boards and capabilities.

I/O Driver Block Library

Real-Time Windows Target software provides a custom Simulink block library. The I/O driver block library contains universal drivers for supported I/O boards. These universal blocks are configured to operate with the library of supported drivers. This allows easy location of driver blocks and easy configuration of I/O boards.

You drag and drop a universal I/O driver block from the I/O library the same way as you would from a standard Simulink block library. And you connect

an I/O driver block to your model just as you would connect any standard Simulink block.

You create a real-time application in the same way as you create any other Simulink model, by using standard blocks and C-code S-functions. You can add input and output devices to your Simulink model by using the I/O driver blocks from the `rtwlib` library provided with the Real-Time Windows Target software. This library contains the following blocks:

- Analog Input
- Analog Output
- Counter Input
- Digital Input
- Digital Output
- Encoder Input
- Frequency Output
- Packet Input
- Packet Output
- Stream Input
- Stream Output

The Real-Time Windows Target software provides driver blocks for more than 200 I/O boards. These driver blocks connect the physical world to your real-time application:

- Sensors and actuators are connected to I/O boards.
- I/O boards convert voltages to numerical values and numerical values to voltages.
- Numerical values are read from or written to I/O boards by the I/O drivers.

Software Environment

In this section...
“Non-Real-Time Simulation” on page 1-12
“Real-Time Execution” on page 1-12
“Development Process” on page 1-13

Non-Real-Time Simulation

You create a Simulink model and use Simulink software in normal mode for non-real-time simulation on your PC computer.

Simulink model — Create block diagrams with Simulink software by using simple drag-and-drop operations, and then enter values for the block parameters and select a sample rate.

Non-real-time simulation — Simulink software uses a computed time vector to step your Simulink model. After the outputs are computed for a given time value, the Simulink software immediately repeats the computations for the next time value. This process is repeated until it reaches the stop time.

Because this computed time vector is not connected to a hardware clock, the outputs are calculated in nonreal time as fast as your computer can run. The time to run a simulation can differ significantly from real time.

Real-Time Execution

For real-time execution on your PC computer, create a real-time application and use Simulink external mode, Real-Time Workshop code generation software, Real-Time Windows Target software, and the Open Watcom C/C++ compiler, to produce an executable that the kernel can run in real time. This real-time application uses the initial parameters available from your Simulink model at the time of code generation.

If you use continuous-time components in your model and create code with Real-Time Workshop code generation software, you must use a fixed-step integration algorithm. Real-Time Windows Target software provides the capabilities necessary for using the real-time resources on your computer

hardware. Based on your selected sample rate, Real-Time Windows Target software uses interrupts to step your application in real time at the proper rate. With each new interrupt, the executable computes all of the block outputs from your model.

Development Process

With Real-Time Windows Target rapid prototyping software, you can use your desktop PC with the MATLAB environment, Simulink software, Real-Time Workshop code generation software, and Real-Time Windows Target software to:

- 1 Design a control system** — Use the MATLAB environment and Control System Toolbox™ software to design and select the system coefficients for your controller.
- 2 Create a Simulink model** — Use Simulink blocks to graphically model your physical system.
- 3 Run a simulation in nonreal time** — Check the behavior of your model before you create a real-time application. For example, you can check the stability of your model.
- 4 Create a real-time application** — Real-Time Workshop code generation software creates C code from your Simulink model. The Open Watcom C/C++ compiler compiles the C code to an executable that runs with the Real-Time Windows Target kernel.
- 5 Run an application in real time** — Your desktop PC is the target computer to run the real-time application.
- 6 Analyze and visualize signal data** — Use MATLAB functions to plot data saved to the MATLAB workspace or a disk.

Note Although Real-Time Windows Target applications run on the same hardware as Windows, the Real-Time Windows Target kernel and the Win32 kernel are incompatible. When a Real-Time Windows Target application includes externally created code, such as a custom I/O driver block or a user-supplied S-function, the code cannot access any Win32 function. For more information, see “Incompatibility with Win32 API Calls” on page A-4.

System Concepts

In this section...
“Simulink External Mode” on page 1-15
“Data Buffers and Transferring Data” on page 1-16

Simulink External Mode

External mode requires a communications interface to pass external parameters. On the receiving end, the same communications protocol must be used to accept new parameter values and insert them in the proper memory locations for use by the real-time application. In some Real-Time Workshop targets such as Tornado/VME targets, the communications interface uses TCP/IP protocol. In the case of a Real-Time Windows Target application, the host computer also serves as the target computer. Therefore, only a virtual device driver is needed to exchange parameters between the MATLAB environment, Simulink memory space, and memory that is accessible by the real-time application.

Signal acquisition — You can capture and display signals from your real-time application while it is running. Signal data is retrieved from the real-time application and displayed in the same Simulink Scope blocks you used for simulating your model.

Parameter tuning — You can change parameters in your Simulink block diagram and have the new parameters passed automatically to the real-time application. Simulink external mode changes parameters in your real-time application while it is running in real time.

Note that if you open a source block to change parameters, the simulation will pause while the block dialog box is open. You must close the dialog by clicking **OK**, which will resume the simulation.

As a user of Real-Time Windows Target rapid prototyping software, you will find that the requirements for setup are minimal. You start by enabling external mode. You then choose the Real-Time Workshop system target file from the Configuration Parameters dialog **Real-Time Workshop** tab. The MEX-file interface is automatically selected when you choose the target

file. Then, after you have built the real-time application, you are ready for external mode operation.

Data Buffers and Transferring Data

At each sample interval of the real-time application, Simulink software stores contiguous data points in memory until a data buffer is filled. Once the data buffer is filled, Simulink software suspends data capture while the data is transferred back to the MATLAB environment through Simulink external mode. Your real-time application, however, continues to run. Transfer of data is less critical than maintaining deterministic real-time updates at the selected sample interval. Therefore, data transfer runs at a lower priority in the remaining CPU time after model computations are performed while waiting for another interrupt to trigger the next model update.

Data captured within one buffer is contiguous. When a buffer of data has been transferred, it is immediately plotted in a Simulink Scope block, or it can be saved directly to a MAT-file using the data archiving feature of the Simulink external mode.

With data archiving, each buffer of data can be saved to its own MAT-file. The MAT-file names can be automatically incremented, allowing you to capture and automatically store many data buffers. Although points within a buffer are contiguous, the time required to transfer data back to the Simulink software forces an intermission for data collection until the entire buffer has been transferred and may result in lost sample points between data buffers.

Installation and Configuration

- “Required Products” on page 2-2
- “Related Products” on page 2-5
- “System Requirements” on page 2-6
- “Real-Time Windows Target Installed Files” on page 2-8
- “Initial Working Directory” on page 2-10
- “Real-Time Windows Target Kernel” on page 2-12
- “Testing the Installation” on page 2-17

Required Products

In this section...
“Platform” on page 2-2
“The MATLAB Environment” on page 2-2
“Simulink Software” on page 2-2
“Real-Time Workshop Code Generation Software” on page 2-3

Platform

Real-Time Windows Target rapid prototyping software is a self-targeting system where the host and the target computer are the same computer. You can install it on a PC-compatible computer running Microsoft Windows XP 32-bit or Microsoft Windows Vista 32-bit.

Real-Time Windows Target software requires the installation of the MATLAB environment, Simulink software, Real-Time Workshop code generation software, and the Real-Time Windows Target kernel.

The MATLAB Environment

The MATLAB environment provides the design and analysis tools that you use when creating Simulink block diagrams. For information on using the MATLAB environment, see *Getting Started with MATLAB*, which explains how to work with data and how to use MATLAB functions. For a reference describing the functions supplied with the MATLAB environment, see the *MATLAB Function Reference*.

Simulink Software

Simulink software provides an environment where you model your physical system and controller as a block diagram. You create the block diagram by using a mouse to connect blocks and a keyboard to edit block parameters. C code S-functions are supported by Real-Time Workshop code generation software.

Unsupported Simulink blocks — You can use Real-Time Windows Target software with most Simulink blocks including discrete-time and continuous-time systems. Real-Time Windows Target software does not support blocks that do not run in real time, nor does it support To File blocks.

Limitations with Real-Time Workshop code generation software — When you use a continuous-time system and generate code with Real-Time Workshop code generation software, you must use a fixed-step integration algorithm. However, M-code S-functions are not supported.

Real-Time Windows Target I/O driver blocks — With Real-Time Windows Target software, you can remove the physical system model and replace it with I/O driver blocks connected to your sensors and actuators. The Real-Time Windows Target I/O library supports more than 200 boards.

Note Some of the functions on a board may not be supported by Real-Time Windows Target software. Check the MathWorks Web site for an updated list of supported boards and functions at Supported I/O Boards.

Simulink documentation — For information on Simulink software, see *Simulink User's Guide*, which explains how to connect blocks to build models and change block parameters. It also provides a reference that describes each block in the standard Simulink library.

Real-Time Workshop Code Generation Software

Real-Time Workshop code generation software provides the utilities to convert your Simulink models into C code, and then, with the Open Watcom C/C++ compiler, compile the code into a real-time executable.

Real-Time Windows Target software is designed for maximum flexibility during rapid prototyping. This flexibility allows parameter tuning and signal tracing during a real-time run, but increases the size of the generated code. However, Real-Time Workshop code generation software provides other code formats that generate the more compact code needed for embedded applications.

Real-Time Workshop documentation — For information on code generation, see the *Real-Time Workshop User's Guide*.

Related Products

The MathWorks™ provides several products that are especially relevant to the kinds of tasks you can perform with Real-Time Windows Target software. For more information about any of these products, see either:

- The online documentation for that product if it is installed on your system
- The MathWorks Web site, at
<http://www.mathworks.com/products/rtwt/related.jsp>.

System Requirements

In this section...
“Platform Requirements” on page 2-6
“Hardware Requirements” on page 2-6
“Software Requirements” on page 2-6

Platform Requirements

The Real-Time Windows Target software requires a PC-compatible computer.

Hardware Requirements

The following table lists the minimum hardware resources that the Real-Time Windows Target software requires on your computer.

Hardware	Description
CPU	Pentium or higher in a desktop, laptop, or compact PCI or PC104 industrial computer
Peripherals	Hard disk drive with 16 megabytes of free space Data acquisition board (for a list of supported boards, see Supported I/O Boards) DVD drive
RAM	128 megabytes minimum, 256 megabytes recommended

When you are using a laptop computer, Real-Time Windows Target software provides a portable environment where your computer uses PCMCIA cards to interface to real world devices.

Software Requirements

Real-Time Windows Target software has certain prerequisites that must be met for proper installation and execution.

The following table lists the products you need to install on your computer to run Real-Time Windows Target software:

- Microsoft Windows XP 32-bit or Microsoft Windows Vista 32-bit
- MATLAB 7.9
- Simulink 7.4
- Real-Time Workshop 7.4
- Real-Time Windows Target 3.4

The Real-Time Windows Target software does not support the Simscape™ or SimDriveline™ products.

Real-Time Windows Target Installed Files

You can install Real-Time Windows Target software as part of the regular installation process documented in MathWorks™ installation guides. This section describes installed files that are unique to Real-Time Windows Target software. When using the product, you may find it helpful to know where these files are located.

- **MATLAB working directory** — Simulink models (`model.mdl`) and the Real-Time Windows Target executable (`model.rwd`)

Note Select a working directory outside the MATLAB root. See “Initial Working Directory” on page 2-10.

- **Real-Time Workshop project directory** — The Real-Time Workshop C-code files (`model.c`, `model.h`) are in a subdirectory called `model_rtwin`.
- **Real-Time Windows Target Files** — The files included with Real-Time Windows Target software are located in the directory

```
matlabroot\toolbox\rtw\targets\rtwin
```

- **Open Watcom C/C++ compiler directory** — The Open Watcom C/C++ compiler files are located in a subdirectory called `openwat`.

Real-Time Windows Target software provides files to help Real-Time Workshop code generation software create C code from your Simulink model and compile that code to a real-time executable:

- **System Target File** (`rtwin.tlc`) — Defines the process of generating C code by Real-Time Windows Target software.
- **Template Makefile and Makefile** (`rtwin.tmf`, `model_name.mk`) — The template makefile serves as a template for generating the real makefile, which the `make` utility uses during model compilation. During the automatic build procedure, the `make` command extracts information from the template makefile `rtwintmf.m` and generates the makefile `model_name.mk`.

- **Make Command** (`make_rtw.m`) — The standard `make` command supplied with Real-Time Workshop code generation software.

Other files provided with Real-Time Windows Target software include

- **I/O drivers** (`*.rwd`) — Binaries for I/O device drivers. Real-Time Windows Target software does not link the driver object files with your real-time executable. The drivers are loaded into memory and run by the kernel separately.
- **Simulink external mode interface** (`rtwinext.mex*`) — MEX-file for communicating between Simulink external mode and the Real-Time Windows Target kernel.

Simulink external mode uses the MEX-file interface module to download new parameter values to the real-time model and to retrieve signals from the real-time model. You can display these signals in Simulink Scope blocks.

- **Kernel install and uninstall commands** (`rtwintgt.m`, `rtwho.m`) — `.m` scripts to install and uninstall the Real-Time Windows Target kernel and check installation.

Initial Working Directory

In this section...
“Working Directory Location Requirement” on page 2-10
“Setting the Working Directory from the Desktop Icon” on page 2-10
“Setting the Working Directory from the MATLAB Environment” on page 2-10

Working Directory Location Requirement

Set your MATLAB working directory outside the MATLAB root directory. The default MATLAB root directory is `c:\matlabN`, where *N* is the MATLAB version number.

Setting the Working Directory from the Desktop Icon

Your initial working directory is specified in the shortcut file you use to start the MATLAB environment. To change this initial directory, use the following procedure:

- 1 Right-click the MATLAB desktop icon, or from the program menu, right-click the MATLAB shortcut.
- 2 Click **Properties**. In the **Start in** text box, enter the directory path you want the MATLAB environment to use initially outside the MATLAB root directory.
- 3 Click **OK**, and then start the MATLAB environment. To check your working directory, type

`pwd` or `cd`

Setting the Working Directory from the MATLAB Environment

Use the following procedure as an alternative, but temporary, procedure for setting your MATLAB working directory:

- 1 In the MATLAB Command Window, type

```
cd c:\mwd
```

2 Check the current working directory, type

```
cd
```

The MATLAB Command Window displays

```
ans = c:\mwd or c:\mwd
```

Real-Time Windows Target Kernel

In this section...
“About the Kernel” on page 2-12
“Installing the Kernel” on page 2-12
“Uninstalling the Kernel” on page 2-14

About the Kernel

The Real-Time Windows Target software includes a real-time kernel that interfaces with the Windows operating system. The Real-Time Windows Target kernel assigns the highest priority of execution to your real-time executable, which allows it to run without interference at the selected sample rate. During real-time execution of your model, the kernel intervenes when needed to ensure that the model is given priority to use the CPU to execute each model update at the prescribed sample times. Once a model update completes, the kernel releases the CPU to run any other Windows based application that might need servicing.

Installing the Kernel

During software installation, all Real-Time Windows Target software is copied onto your hard drive, but the Real-Time Windows Target kernel is not automatically installed into the operating system. You must install the kernel before you can run a Real-Time Windows Target application. Installing the kernel configures it to start running in the background each time you start your computer. The following procedure describes how to use the command `rtwintgt -install`. You can also use the command `rtwintgt -setup` instead. To install the kernel:

1 In the MATLAB Command Window, type:

```
rtwintgt -install
```

or:

■ Click the MATLAB **Start** button.

b Select Links and Targets > Real-Time Windows Target > Install real-time kernel

The MATLAB Command Window displays one of these messages:

```
You are going to install the Real-Time Windows Target kernel.  
Do you want to proceed? [y] :
```

or:

```
There is a different version of the Real-Time Windows Target kernel installed.  
Do you want to update to the current version? [y] :
```

- 2** Type `y` to continue installing the kernel, or `n` to cancel installation without making any changes.

If you type `y`, the MATLAB environment installs the kernel and displays the message:

```
The Real-Time Windows Target kernel has been successfully installed.
```

- 3** If a message appears asking you to restart your computer, do so before attempting to use the kernel, or your Real-Time Windows Target model will not run correctly.
- 4** After installing the kernel, verify that it was correctly installed by typing:

```
rtwho
```

The MATLAB Command Window should display a message that shows the kernel version number, followed by performance, timeslice, and other information.

Once the kernel is installed, you can leave it installed. The kernel remains idle after you have installed it, which allows the Windows operating system to control the execution of any standard Windows based application, including Internet browsers, word processors, the MATLAB environment, and so on. The kernel becomes active when you begin execution of your model, and becomes idle again after model execution completes.

Uninstalling the Kernel

If you encounter any problems with Real-Time Windows Target software, you can uninstall the kernel. Once uninstalled, the kernel is no longer active and has no impact on the operation of your computer. The kernel executable file remains on your hard drive so that you can later reinstall it. To uninstall the kernel:

- 1 In the MATLAB Command Window or a DOS window, type:

```
rtwintgt -uninstall
```

or:

- a Click the MATLAB **Start** button.
- b Select **Links and Targets > Real-Time Windows Target > Uninstall real-time kernel**

The MATLAB Command Window displays the message:

```
You are going to uninstall the Real-Time Windows Target kernel.  
Do you want to proceed? [y]:
```

- 2 Type **y** to continue uninstalling the kernel, or **n** to cancel uninstallation without making any changes.

If you type **y**, the MATLAB environment uninstalls the kernel by removing it from memory, then displays the message:

```
The Real-Time Windows Target kernel has been successfully uninstalled.
```

- 3 After uninstalling the kernel, verify that it was correctly uninstalled: Type:

```
rtwho
```

The MATLAB environment should display the following message.

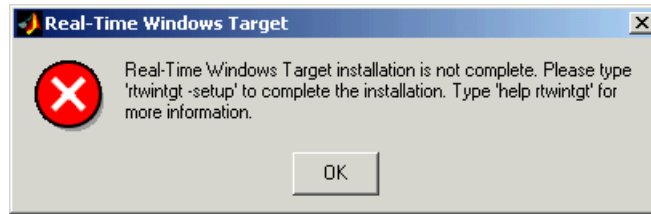

If the uninstallation fails, see “Forcibly Uninstalling the Kernel” on page 2-16 .

Uninstalling the Kernel Without MATLAB

Uninstalling the MATLAB environment does not uninstall the Real-Time Windows Target kernel. If you have uninstalled the MATLAB environment and need to uninstall the kernel, launch a DOS command shell and type:

```
rtwintgt -uninstall
```

The kernel should then uninstall from your system. If the uninstallation fails, see “Forcibly Uninstalling the Kernel” on page 2-16 .

Forcibly Uninstalling the Kernel

If you cannot uninstall the kernel with `rtwintgt -uninstall`, something has corrupted the Real-Time Windows Target kernel service. To uninstall the kernel:

- 1 In the MATLAB Command Window or a DOS command shell, type:

```
rtwintgt -forceuninstall
```

The command forcibly deregisters the kernel from the operating system without deleting any files.

- 2 Restart the computer before attempting any other action, including reinstalling the kernel.

Use `rtwintgt -forceuninstall` only when all other attempts to uninstall the kernel fail. The command leaves the computer in an inconsistent state that cannot be relied on and does not post relevant error messages.

Note Never execute `rtwintgt -forceuninstall` without immediately rebooting, after which you can reinstall the Real-Time Windows Target kernel as described in “Installing the Kernel” on page 2-12.

Testing the Installation

In this section...

“About Installation Testing” on page 2-17

“Running the Model `rtvdp.mdl`” on page 2-17

“Displaying Status Information” on page 2-19

“Detecting Excessive Sample Rates” on page 2-20

“Demo Library” on page 2-21

About Installation Testing

Real-Time Windows Target includes several demo models. You can use the demo models to test your installation. Demo models simplify testing of your installation since they are configured with settings that include the correct target, scope settings, sample time, and integration algorithm. To see these demo models, type `rtwtdemo` in the MATLAB Command Window.

Once you have completed the installation of the Real-Time Windows Target software and kernel, we recommend a quick test by running the model `rtvdp.mdl`. If you change your installation, we also recommend doing this test as a quick check to confirm that the Real-Time Windows Target software is still working. To open the demo model, type `rtvdp` in the MATLAB Command Window, or launch MATLAB Online Help and choose **Real-Time Windows Target > Demos > Real-Time Van der Pol Simulation**.

Running the Model `rtvdp.mdl`

The model `rtvdp.mdl` does not have any I/O blocks, so that you can run this model regardless of the I/O boards in your computer. Running this model will test the installation by running Real-Time Workshop code generation software, Real-Time Windows Target software, and the Real-Time Windows Target kernel.

After you have installed the Real-Time Windows Target kernel, you can test the entire installation by building and running a real-time application. The Real-Time Windows Target software includes the model `rtvdp.mdl`, which already has the correct Real-Time Workshop options selected for you:

1 In the MATLAB Command Window, type

```
rtvdp
```

The Simulink model `rtvdp.mdl` window opens.

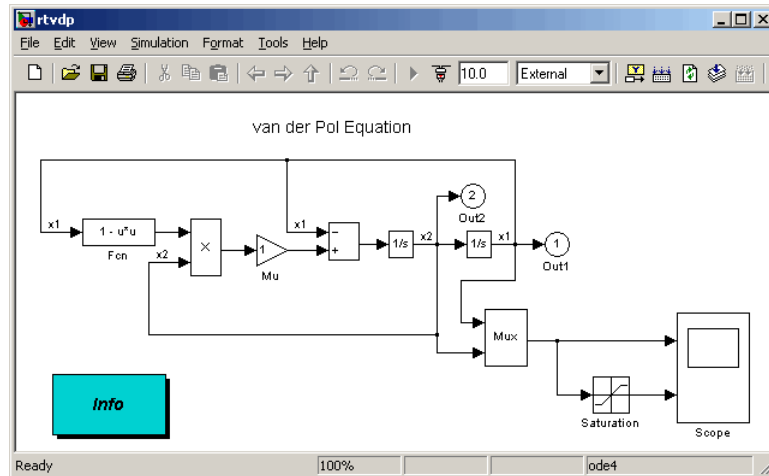

2 From the **Tools** menu, choose **Real-Time Workshop > Build Model**.

The MATLAB Command Window displays the following messages:

```
### Starting Real-Time Workshop build for model: rtvdp
### Invoking Target Language Compiler on rtvdp.rtw
. . .
### Compiling rtvdp.c
. . .
### Created Real-Time Windows Target module rtvdp.rwd.
### Successful completion of Real-Time Workshop build procedure
for model: rtvdp
```

3 From the **Simulation** menu, click **External**, and then click **Connect to target**.

The MATLAB Command Window displays the following message:

```
Model rtvdp loaded
```

4 From **Simulation** menu, click **Start Real-Time Code**.

The Scope window displays the output signals. If your Scope window looks like the next figure, you have successfully installed the Real-Time Windows Target software and have run a real-time application.

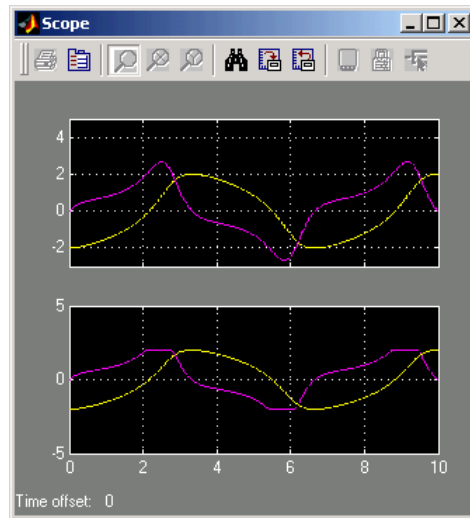

5 From **Simulation** menu, click **Stop Real-Time Code**.

The real-time application stops running, and the Scope window stops displaying the output signals.

Displaying Status Information

The Real-Time Windows Target software provides the command `rtwho` for displaying the kernel version number, followed by performance, `timeslice`, and other information. To see this information, in the MATLAB Command Window type

```
rtwho
```

The command displays several lines of information in the MATLAB Command Window. Some possible lines and their interpretations are:

```
MATLAB performance = 100.0%
```

This message indicates that the MATLAB environment and other non-real-time applications (for example, a word processor) are able to run at 100% performance because no real-time applications are currently executing. When a real-time application is executing, the MATLAB performance is at a value below 100%. For example, if the MATLAB performance = 90.0%, then the real-time application is using 10% of the CPU time. We recommend that you select a sample rate so that `rtwho` returns a MATLAB performance of at least 80%.

```
Kernel timeslice period = 1 ms
```

The kernel time slice period is the current frequency of the hardware timer interrupt. One millisecond is the maximum value for models with large sample times (slow sampling rate) or when an application has not been built. This value changes when you select sampling times less than 1 millisecond.

```
TIMERS:  Number   Period  Running
          1       0.01    Yes
```

The indicated timer(s) exist on your system with the period and run status shown for each timer.

```
DRIVERS:           Name      Address  Parameters
                  Humusoft AD512    0x300    [ ]
                  ecg       0        [ ]
```

The indicated device driver(s) are installed on your system at the address and with the parameter(s) shown for each driver.

Detecting Excessive Sample Rates

If your specified sample rate is too fast, the Real-Time Windows Target software detects and reports this during real-time execution. Sampling rates exceeding 10 kHz can be achieved on Pentium computers. Once the model is running, you can issue the `rtwho` command in the MATLAB Command Window to observe the system performance.

For example, the following lines show that MATLAB performance has decreased because the system is overloaded:

```
MATLAB performance = 77.1%  
Kernel timeslice period = 0.001 ms
```

We recommend that MATLAB performance not fall below 80%.

Demo Library

The demo library includes models with preset values and dialog boxes. These models include a configuration of examples that use no I/O, A/D only, A/D and D/A in a simple signal processing demo, as well as in a simple control demo. Examples that use I/O blocks require you to configure the Adapter block to match the I/O board installed in your computer. To see these demo models from the MATLAB environment:

- 1 Type `rtwtdemo` in the MATLAB Command Window.

The Real-Time Windows Target Demos window displays.

- 2 From the list, select the demo to open it.

Basic Procedures

- “Using Simulink Models” on page 3-2
- “Using Real-Time Applications” on page 3-14
- “Logging Signals to the Base Workspace” on page 3-27
- “Logging Signals to a Disk Drive” on page 3-34
- “Tuning Parameters” on page 3-44

Using Simulink Models

In this section...

“About Simulink Models” on page 3-2

“Creating a Model” on page 3-2

“Configuring a Model” on page 3-6

“Running a Simulation” on page 3-12

About Simulink Models

A Simulink model is a graphical representation of your physical system. You create a Simulink model for a non-real-time simulation of your system, and then you use the Simulink model to create a real-time application.

Creating a Model

You need to create a Simulink model before you can run a simulation or create a real-time application. This procedure explains how to create a simple Simulink model. You can use this model as an example to learn other procedures that are useful with Real-Time Windows Target software.

- 1 In the MATLAB Command Window, type

```
simulink
```

The Simulink Library Browser opens. The left pane shows a hierarchy of libraries and block categories, with the Simulink library at the top. The right pane shows the blocks available in the category selected on the left. See “Library Browser” for more information.

- 2 Choose **File > New > Model**, or click the **New model** button on the toolbar.

An empty Simulink window opens:

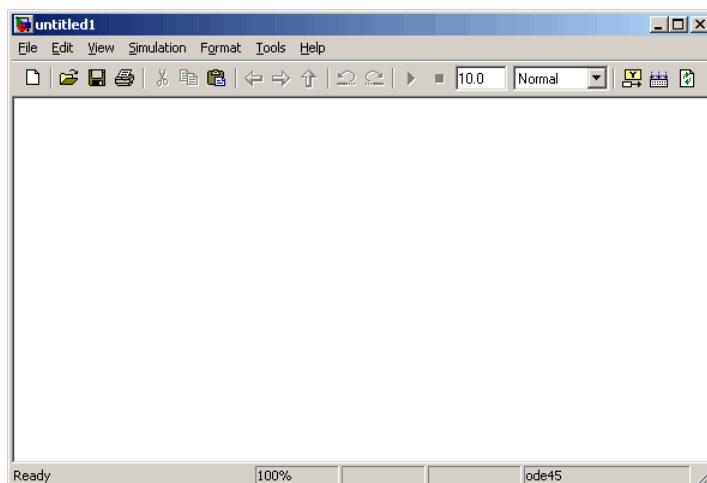

- 3** In the left pane of the Simulink Library Browser window, select **Simulink > Sources**. Click and drag a **Signal Generator** block from the browser to the Simulink window.

Select **Continuous**. Click and drag a **Transfer Fcn** block to the Simulink window.

Select **Sinks**. Click and drag a **Scope** block to the Simulink window.

- 4** Connect the **Signal Generator** output to the **Transfer Fcn** input by clicking-and-dragging a line between the blocks. Likewise, connect the **Transfer Fcn** output to the **Scope** input.
- 5** Double-click the **Transfer Fcn** block. The Block Parameters dialog box opens. In the **Numerator** text box, enter:

[10000]

In the **Denominator** text box, enter

[1 70 10000]

Your Block Parameters dialog box looks similar to the next figure.

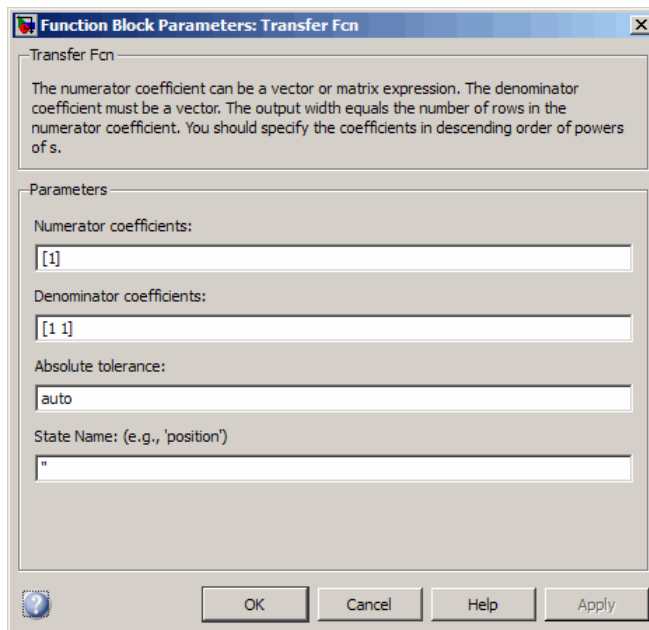

6 Click **OK**.

7 Double-click the Signal Generator block. The Block Parameters dialog box opens. From the **Wave form** list, select **square**.

In the **Amplitude** text box, enter

1

In the **Frequency** text box, enter

20

From the **Units** list, select rad/sec.

Your Block Parameters dialog box looks similar to the next figure.

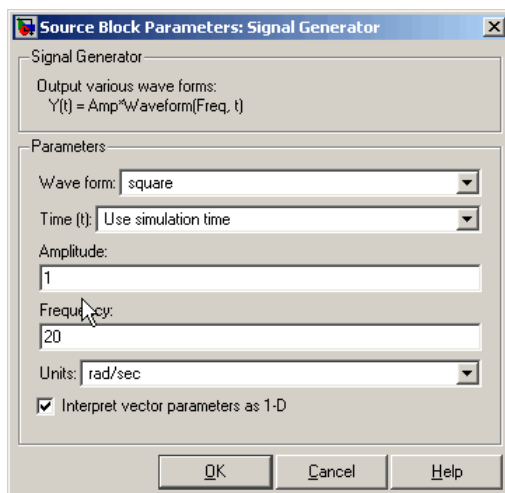

8 Click **OK**.

The next figure shows the completed Simulink block diagram, with toolbar and status bar not shown:

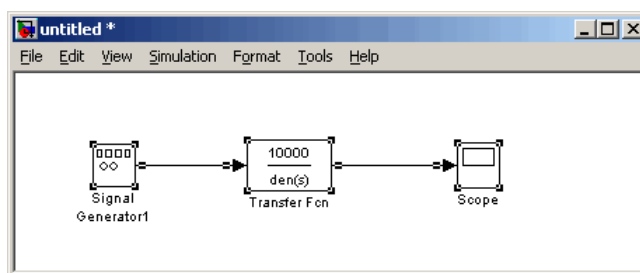

9 From the **File** menu, click **Save As**. The Save As dialog box opens. In the **File name** text box, enter a file name for your Simulink model and click **Save**. For example, type

```
rtwin_model
```

The Simulink software saves your model in the file `rtwin_model.mdl`.

To specify a default Real-Time Windows Target configuration set for your model, see “Specifying the Default Configuration Set” on page 3-7. If you

activate this configuration set for your model, you can build your real-time application later without setting additional configuration parameters.

To manually configure your model, continue to “Entering Configuration Parameters Manually” on page 3-8, following. That section teaches you how to enter configuration parameters for your Simulink model, then leads you into procedures for entering scope parameters and running a non-real-time simulation of the model.

Model Referencing

The Real-Time Windows Target software supports model referencing. See “Referencing a Model” in the *Simulink User’s Guide* guide for more information.

File System Input/Output

Like most real-time environments, the Real-Time Windows Target software does not include a file system. Therefore, a Simulink model intended for use in a Real-Time Windows Target application cannot use any blocks, such as the To File or From File block, that generate file I/O calls such as `fopen` or `printf`.

If a Real-Time Windows Target model contains any block that tries to perform file system I/O, an error could occur when you try to compile the model, generate code for it, or use External Mode with it. Even if no error occurs, the block has no effect on either simulation or code execution.

To log signal data without needing a file system, use the techniques described in “Logging Signals to a Disk Drive” on page 3-34. See “Running a Real-Time Application” on page 3-23 for information about using External Mode to execute a Real-Time Windows Target application.

Configuring a Model

After you create a Simulink model, you can enter configuration parameters for the model. These parameters control many properties of the model for simulation and code generation. This section contains the essential information you need when setting configuration parameters for a Real-Time Windows Target application. For complete information about Simulink

configuration parameters, see “Setting Up Configuration Sets” and “Configuration Parameters Dialog Box”.

A configuration set is a named set of values for model parameters, such as solver type and simulation start or stop time. Every new model is created with a default configuration set, called `Configuration`, that initially specifies default values for the model’s model parameters. You can subsequently create additional configuration sets and associate them with the model, as described in “Referencing Configuration Sets”.

The easiest way to specify configuration parameters for a Real-Time Windows Target model is to programmatically assign the default Real-Time Windows Target configuration set, as described in “Specifying the Default Configuration Set” on page 3-7. You can also set parameters manually, as described in “Entering Configuration Parameters Manually” on page 3-8. Other sections describe setting configuration patterns for specific purposes.

Specifying the Default Configuration Set

After you create a Simulink model, you can use the `rtwinconfigset` function to specify a default Real-Time Windows Target configuration set for the model. In most cases, using `rtwinconfigset` provides all the configuration parameter values that the model needs. The following procedure uses the Simulink model `rtwin_model.mdl` as an example and assumes you have already loaded that model (see “Creating a Model” on page 3-2):

- 1 If you have not already saved the model, from the **File** menu, click **Save As**. The Save As dialog box opens. In the **File name** text box, enter a file name for your Simulink model and click **Save**. For example, type

```
rtwin_model
```

The Simulink software saves your model in the file `rtwin_model.mdl`.

- 2 In the MATLAB Command Window, type

```
rtwinconfigset('rtwin_model')
```

The default Real-Time Windows Target configuration set, `RTWin`, is now active for the `rtwin_model` model. (Alternatively, you can set the default Real-Time Windows Target configuration set by setting the Configuration

Parameters **System target file** option to `rtwin.tlc`.) You do not need to perform any other configuration for a Real-Time Windows Target application.

3 Save the model.

See “Creating a Real-Time Application” on page 3-19 for a description of how to build your Real-Time Windows Target application.

To revert to the default configuration set, Configuration, or any other configuration set you have for the model, use Model Explorer. This is an alternative tool that you can use to enter simulation parameters for a model. See the Simulink documentation for a description of how to use Model Explorer.

Note Your model uses a Real-Time Windows Target configuration set when you change the **System target file** value to a Real-Time Windows Target one, such as `rtwin.tlc` or `rtwinert.tlc`. The software creates the Real-Time Windows Target configuration set, RTWin or RTWinERT, only if one does not already exist.

Entering Configuration Parameters Manually

The configuration parameters give information to Simulink software for running a simulation. This procedure uses the Simulink model `rtwin_model.mdl` as an example and assumes you have already loaded that model:

- 1 In the Simulink window, and from the **Simulation** menu, click **Configuration Parameters**. In the Configuration Parameters dialog box, click the **Solver** tab.

The **Solver** pane opens.

- 2 In the **Start time** field, enter `0.0`. In the **Stop time** field, enter the amount of time you want your model to run. For example, enter `10.0` seconds.
- 3 From the **Type** list, choose **Fixed-step**. Real-Time Workshop code generation software does not support variable step solvers.

- 4 From the **Solver** list, choose a solver. For example, choose the general purpose solver ode5 (Dormand-Prince).
- 5 In the **Fixed step size** field, enter a sample time. For example, enter 0.001 seconds for a sample rate of 1000 samples/second.
- 6 From the **Tasking Mode** list, choose SingleTasking. (For models with blocks that have different sample times, choose MultiTasking.)

Your **Solver** pane looks similar to the next figure.

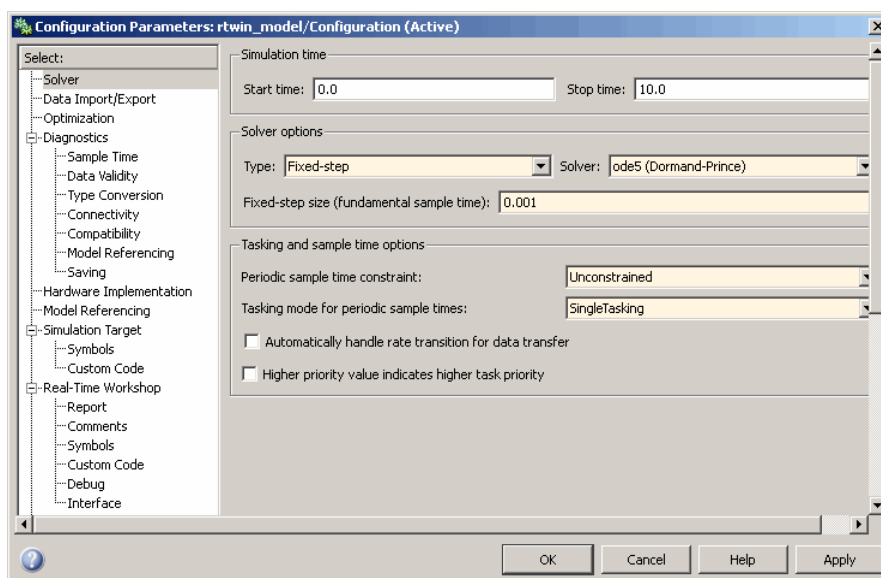

- 7 Do one of the following:
 - Click **Apply** to apply the changes to your model and leave the dialog box open.
 - Click **OK** to apply the changes to your model and close the dialog box.

Entering Scope Parameters for Signal Tracing

You enter or change scope parameters to specify the x -axis and y -axis in a Scope window. Other properties include the number of graphs in one Scope window and the sample time for models with discrete blocks.

After you add a Scope block to your Simulink model, you can enter the scope parameters for signal tracing:

- 1 In the Simulink window, double-click the Scope block.

A Scope window opens.

- 2 Click the **Parameters** button.

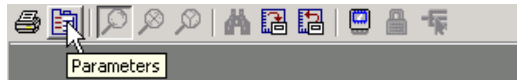

A Scope parameters dialog box opens.

- 3 Click the **General** tab. In the **Number of axes** field, enter the number of graphs you want in one Scope window. For example, enter 1 for a single graph. Do not select the **floating scope** check box.

In the **Time range** field, enter the upper value for the time range. For example, enter 1 second. From the **Tick labels** list, choose **all**.

From the **Sampling** list, choose **Sample time** and enter 0 in the text box. Entering 0 indicates that the Simulink software evaluates this block as a continuous time block. If you have discrete blocks in your model, enter the **Fixed step size** you entered in the Configuration Parameters dialog box.

Your Scope parameters dialog box looks similar to the next figure.

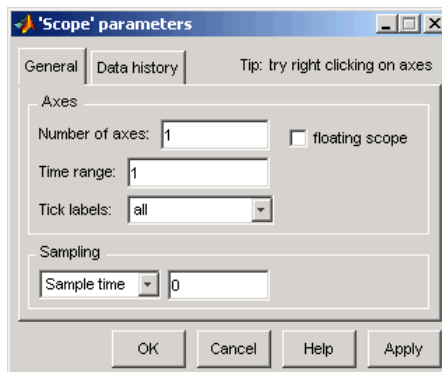

- 4 Do one of the following:
 - Click **Apply** to apply the changes to your model and leave the dialog box open.
 - Click **OK** to apply the changes to your model and close the dialog box.
- 5 In the Scope window, point to the y-axis shown in the next figure, and right-click.

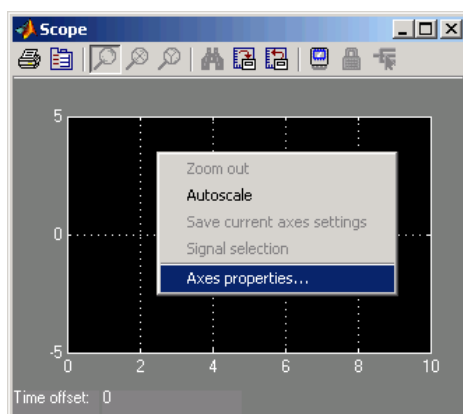

- 6 From the pop-up menu, click **Axes Properties**.
- 7 The Scope properties: axis 1 dialog box opens. In the **Y-min** and **Y-max** text boxes, enter the range for the y-axis in the Scope window. For example, enter -2 and 2 as shown in the next figure.

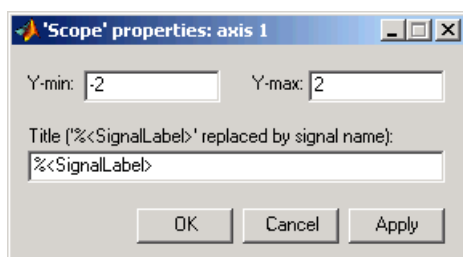

- 8 Do one of the following:

- Click **Apply** to apply the changes to your model and leave the dialog box open.
- Click **OK** to apply the changes to your model and close the dialog box.

Running a Simulation

You use Simulink normal mode to run a non-real-time simulation. Running a simulation lets you observe the behavior of your model in nonreal time.

After you load your Simulink model into the MATLAB workspace, you can run a simulation. This procedure uses the Simulink model `rtwin_model.mdl` as an example and assumes you have loaded that model:

- 1** In the Simulink window, double-click the Scope block.

The Simulink software opens a Scope window with an empty graph.

- 2** From the **Simulation** menu:

- Select **Normal** mode simulation.
- Choose **Start** to begin simulation.

The Simulink software runs the simulation and plots the signal data in the Scope window.

During the simulation, the Scope window displays the samples for one time range, increases the time offset, and then displays the samples for the next time range.

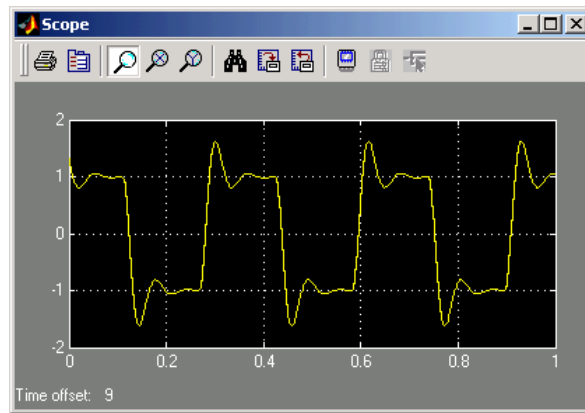

3 Do one of the following:

- Let the simulation run to the stop time.
- From the **Simulation** menu, click **Stop**.

The simulation stops. The MATLAB environment does not display any messages.

Using Real-Time Applications

In this section...

“About Real-Time Applications” on page 3-14

“Entering Simulation Parameters” on page 3-14

“Entering Scope Parameters for Signal Tracing” on page 3-17

“Creating a Real-Time Application” on page 3-19

“Entering Additional Scope Parameters for Signal Tracing” on page 3-20

“Running a Real-Time Application” on page 3-23

“Running an Application from the Command Line” on page 3-25

About Real-Time Applications

You create a real-time application to let your system run while synchronized to a real-time clock. This allows your system to control or interact with an external system. This is necessary if you use your system to stabilize a physical plant. The first step is to create a Simulink Model, as described in the previous section, “Using Simulink Models” on page 3-2.

Entering Simulation Parameters

After you create a Simulink model, you can enter simulation parameters for use by Real-Time Workshop code generation software for creating C code and building a real-time application.

This procedure uses the Simulink model `rtwin_model.mdl` as an example and assumes you have already loaded that model:

- 1** In the Simulink window, and from the **Simulation** menu, click **Configuration Parameters**.

- 2** Click the **Real-Time Workshop** node.

The **Real-Time Workshop** pane opens.

- 3 In the **Target selection** section, click the **Browse** button at the **RTW system target file** list.

The **System Target File Browser** opens.

- 4 Select the system target file for building a Real-Time Windows Target application, and click **OK**.

<code>rsim.tlc</code>	Rapid Simulation Target
<code>rtwin.tlc</code>	Real-Time Windows Target
<code>rtwinert.tlc</code>	Real-Time Windows Target (ERT)
<code>rtwsfcn.tlc</code>	S-function Target

The dialog automatically enters the system target file `rtwin.tlc`, the template makefile `rtwin.tmf`, and the make command `make_rtw` into the **Real-Time Workshop** pane.

If you have the Real-Time Workshop® Embedded Coder™ product, you can build an ERT target application. To build an ERT target application, in the **Target selection** section, click the **Browse** button at the **System target file** list. Click `rtwinert.tlc`, and then click **OK**.

Although not visible in the **Real-Time Workshop** pane, when you click **OK** you also configure the external target interface MEX file `rtwinext`. This allows external mode to pass new parameters to the real-time application and to return signal data from the real-time application. The data is displayed in Scope blocks or saved with signal logging.

Your **Real-Time Workshop** pane looks similar to the next figure.

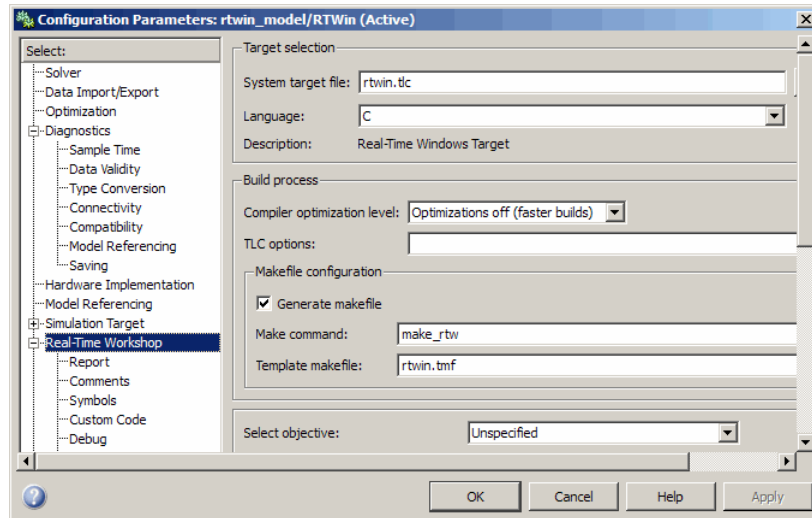

Do not select **Inline parameters** on the **Optimization** node. Inlining parameters is used for custom targets when you want to reduce the amount of RAM or ROM with embedded systems. Also, if you select inlining parameters, you disable the parameter tuning feature. Since PCs have more memory than embedded systems, we recommend that you do not inline parameters.

5 Click the **Hardware Implementation** node. The following values are set by default:

- **Device vendor** — Generic
- **Device type** — 32-bit x86 compatible
- **Emulation hardware** — None

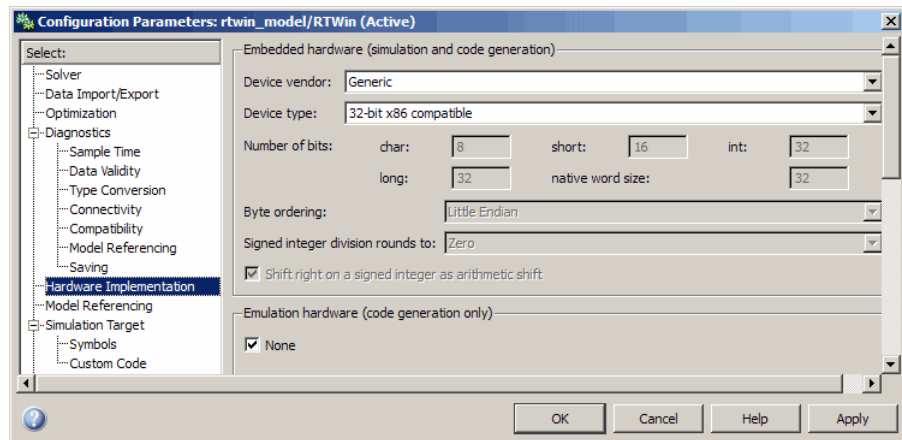

6 Do one of the following:

- Click **Apply** to apply the changes to your model and leave the dialog box open.
- Click **OK** to apply the changes to your model and close the dialog box.

Entering Scope Parameters for Signal Tracing

You enter or change scope parameters to format the x -axis and y -axis in a Scope window. Other parameters include the number of graphs in a one Scope window and whether the scope is connected to a continuous or discrete model.

If you entered the scope parameters for running a simulation, you can skip this procedure. This information is repeated here if you did not run a simulation.

After you add a Scope block to your Simulink model, you can enter the scope parameters for signal tracing:

1 In the Simulink window, double-click the Scope block.

A Scope window opens.

2 Click the Parameters button.



A Scope parameters dialog box opens.

- 3 Click the **General** tab. In the **Number of axes** field, enter the number of graphs you want in one Scope window. For example, enter 1 for a single graph. Do not select the **floating scope** check box.

In the **Time range** field, enter the upper value for the time range. For example, enter 1 second. From the **Tick labels** list, choose all.

From the **Sampling** list, choose **Sample time** and enter 0 in the text box. Entering 0 indicates that the Simulink software evaluates this block as a continuous time block. If you have discrete blocks in your model, enter the **Fixed step size** you entered in the Configuration Parameters dialog box.

Your Scope parameters dialog box looks similar to the next figure.

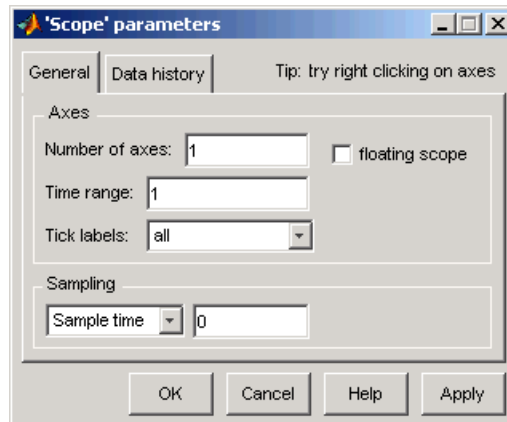

- 4 Do one of the following:
 - Click **Apply** to apply the changes to your model and leave the dialog box open.
 - Click **OK** to apply the changes to your model and close the dialog box.

- 5 In the Scope window, point to the y-axis and right-click. From the menu, click **Axes Properties**.

The Scope properties: axis 1 dialog box opens.

- 6 In the **Y-min** and **Y-max** text boxes enter the range for the y-axis in the Scope window. For example, enter -2 and 2.

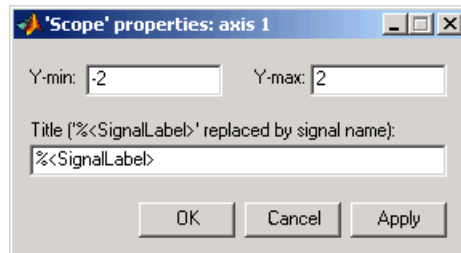

- 7 Do one of the following:
 - Click **Apply** to apply the changes to your model and leave the dialog box open.
 - Click **OK** to apply the changes to your model and close the dialog box.

Creating a Real-Time Application

The Real-Time Workshop code generation software creates C code from your Simulink model, then the Open Watcom C/C++ compiler compiles and links that C code into a real-time application.

After you enter parameters into the Configuration Parameters dialog box for use by the Real-Time Workshop code generation software, you can build a real-time application. This procedure uses the Simulink model `rtwin_model.mdl` as an example, and assumes you have loaded that model:

- 1 In the Simulink window, from the **Tools** menu, point to **Real-Time Workshop**, and then click **Build Model**.

The build process does the following:

- The Real-Time Workshop code generation software creates the C code source files `rtwin_model.c` and `rtwin_model.h`.

- The make utility `make_rtw.exe` creates the makefile `rtwin_model.mk` from the template makefile `rtwin.tmf`.
- The make utility `make_rtw.exe` builds the real-time application `rtwin_model.rwd` using the makefile `rtwin_model.mk` created above. The file `rtwin_model.rwd` is a binary file that we refer to as your real-time application. You can run the real-time application with the Real-Time Windows Target kernel.

- 2** Connect your Simulink model to your real-time application. See “Entering Additional Scope Parameters for Signal Tracing” on page 3-20.

After you create a real-time application, you can exit the MATLAB environment, start the MATLAB environment again, and then connect and run the executable without having to rebuild.

Entering Additional Scope Parameters for Signal Tracing

Simulink external mode connects your Simulink model to your real-time application. This connection allows you to use the Simulink block diagram as a graphical user interface to your real-time application.

After you have created a real-time application, you can enter scope parameters for signal tracing with Simulink external mode:

- 1** In the Simulation window, and from the Simulation menu, click **Configuration Parameters**.
- 2** Select the **Real-Time Windows Target** node.

The **Real-Time Windows Target** pane opens.

- 3** Select the **External mode** check box.

The **MEX-file name** label should have an entry of `rtwinext`. The MEX-file `rtwinext.mex*` is supplied with the Real-Time Windows Target software to work with Simulink external mode and support uploading signal data and downloading parameter values.

The **Real-Time Windows Target** pane should appear as follows.

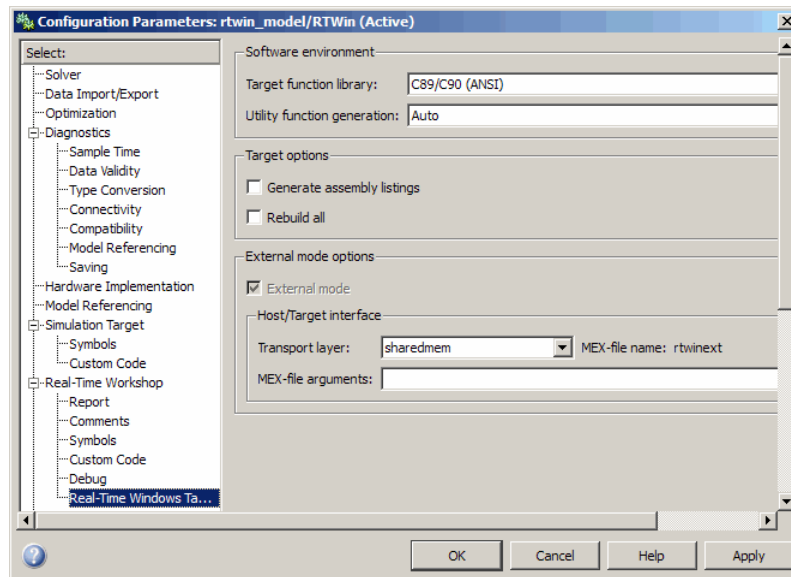

4 Click **OK**.

5 In the Simulation window, and from the **Tools** menu, click **External Mode Control Panel**.

The External Mode Control Panel dialog box opens.

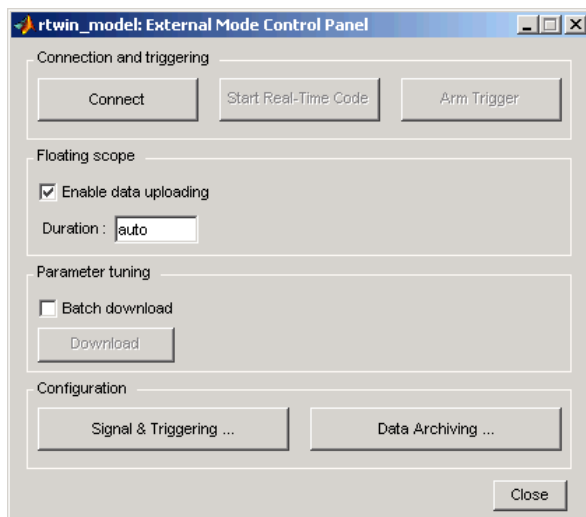

- 6 Click the **Signal & Triggering** button.

The External Signal & Triggering dialog box opens.

- 7 Select the **Select all** check box. From the **Source** list, choose **manual**. From the **Mode** list, choose **normal**.

The X under **Signal selection** indicates that a signal is tagged for data collection, and T indicates that the signal is tagged as a trigger signal.

- 8 In the **Duration** field, enter the number of sample points in a data buffer. For example, to specify a sample rate of 1000 samples/second and a stop time of 10 seconds, enter

10001

- 9 Select the **Arm when connecting to target** check box.

If you do not select this check box, data is not displayed in the Scope window.

The External Signal & Triggering dialog box looks like this:

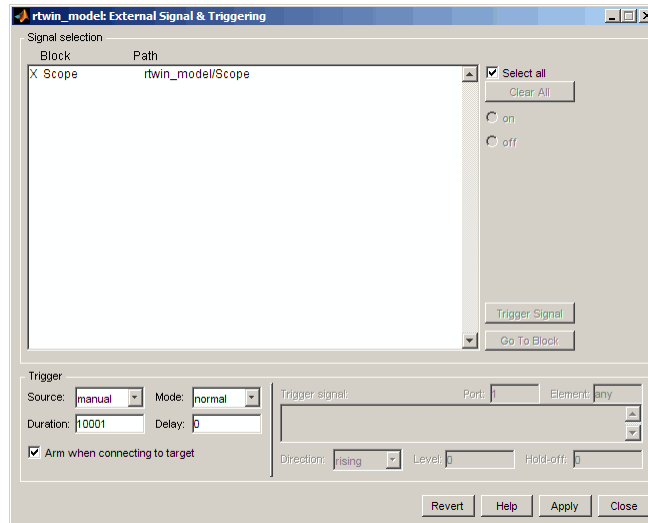

10 Do one of the following:

- Click **Apply** to apply the changes to your model and leave the dialog box open.
- Click **Close** to apply the changes to your model and close the dialog box.

You must click the **Apply** or **Close** button on the External Signal & Triggering dialog box for the changes you made to take effect. Generally it is not necessary to rebuild your real-time application.

Running a Real-Time Application

You run your real-time application to observe the behavior of your model in real time with the generated code. The process of connecting consists of

- Establishing a connection between your Simulink model and the kernel to allow exchange of commands, parameters, and logged data.
- Running the application in real time.

After you build the real-time application, you can run your model in real time. This procedure uses the Simulink model `rtwin_model.mdl` as an example, and assumes you have created a real-time application for that model:

1 From the **Simulation** menu:

- Select **External** mode simulation.
- Choose **Connect To Target**.

(You can connect to the target from the toolbar by clicking ).

The MATLAB Command Window displays the message

```
Model rtwin_model loaded
```

2 From the **Simulation** menu, choose **Start Real-Time Code**.

(You can also start the code from the toolbar by clicking .

The Simulink software runs the execution and plots the signal data in the Scope window.

In this example, the Scope window displays 1000 samples in 1 second, increases the time offset, and then displays the samples for the next 1 second.

Note Transfer of data is less critical than calculating the signal outputs at the selected sample interval. Therefore, data transfer runs at a lower priority in the remaining CPU time after real-time application computations are performed while waiting for another interrupt to trigger the next real-time application update. The result may be a loss of data points displayed in the Scope window.

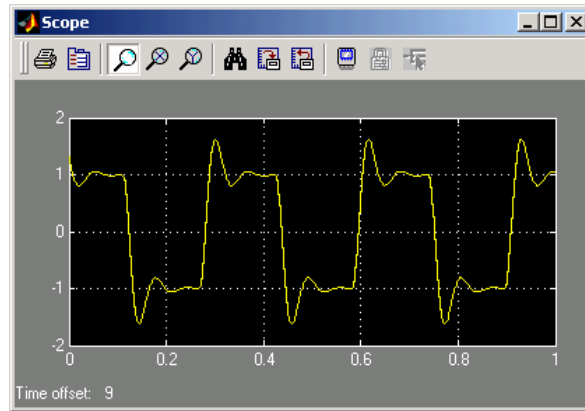

3 Do one of the following:

- Let the execution run until it reaches the stop time.
- From the **Simulation** menu, click **Stop Real-time Code**.

The real-time application stops.

4 In the Simulation window, and from the **Simulation** menu, click **Disconnect From Target**.

5 From the **Simulation** menu, click **External**.

The MATLAB Command Window displays the message

```
Model rtwin_model unloaded
```

Running an Application from the Command Line

You can use the MATLAB command-line interface as an alternative to using the Simulink GUI. Enter commands directly in the MATLAB Command Window or save them in a script file.

After you build the real-time application, you can run your model in real time. This procedure uses the Simulink model `rtwin_model.mdl` as an example, and assumes you have created a real-time application for that model:

1 In the MATLAB Command Window, type

```
set_param(gcs, 'SimulationMode', 'external')
```

The Simulink software changes to external mode.

2 Type

```
set_param(gcs, 'SimulationCommand', 'connect')
```

The MATLAB environment loads the real-time application, connects it to the Simulink block diagram, and displays the message

```
Model rtwin_model loaded
```

3 Type

```
set_param(gcs, 'SimulationCommand', 'start')
```

The Simulink software starts running the real-time application.

4 Type

```
set_param(gcs, 'SimulationCommand', 'stop')
```

The Simulink software stops the real-time application.

Logging Signals to the Base Workspace

In this section...

“About Signal Logging” on page 3-27

“Entering Scope Parameters” on page 3-27

“Entering Signal and Triggering Properties” on page 3-29

“Plotting Logged Signal Data” on page 3-31

About Signal Logging

Signal logging to the base workspace is the process of saving (logging) data to a variable in your MATLAB workspace. This allows you to use MATLAB functions for data analysis and MATLAB plotting functions for visualization. You can save data to a variable during a simulation or during an execution.

Simulink external mode does not support data logging with Outport blocks in your Simulink model. This means you do not enter or select parameters on the **Data I/O** tab in the Configuration Parameters dialog box.

To use signal logging with a Real-Time Windows Target application, you must add a Scope block to your Simulink model.

Entering Scope Parameters

Data is saved to the MATLAB workspace through a Simulink Scope block. Scope block parameters need to be set for data to be saved. After you create a Simulink model and add a Scope block, you can enter the scope parameters for signal logging to the MATLAB workspace. This procedure uses the Simulink model `rtwin_model.mdl` as an example, and assumes you have already loaded that model.

Note If you entered the scope parameters for running a simulation, you may want to look over this procedure, because the Scope parameters dialog box is related to the External Signal and Triggering dialog box.

1 In the Simulink window, double-click the Scope block.

A Scope window opens.

2 On the toolbar, click **Parameters**.



A Scope Parameters dialog box opens.

3 Click the **Data history** tab.

4 Do one of the following:

- If you are running a simulation, select the **Limit data points to last** check box, and enter the number of sample points to save.
- If you are running an execution, do not select the **Limit data points to last** check box.

The **Limit data points to last** check box is related to the **Duration** value in the External Signal and Triggering dialog box. The smaller of either value limits the number of sample points saved to the MATLAB workspace. When you are using Real-Time Windows Target software, use the **Duration** value to set the number of sample points you save. To set the **Duration** value, see the next section.

5 Select the **Save data to workspace** check box. In the **Variable name** text box, enter the name of a MATLAB variable. The default name is ScopeData.

6 From the Format list, choose Structure with time, Structure, or Array (compatible with V2.0-2.2). For example, to save the sample times and signal values at those times, choose Structure with time.

Your **Data history** pane looks similar to the next figure.

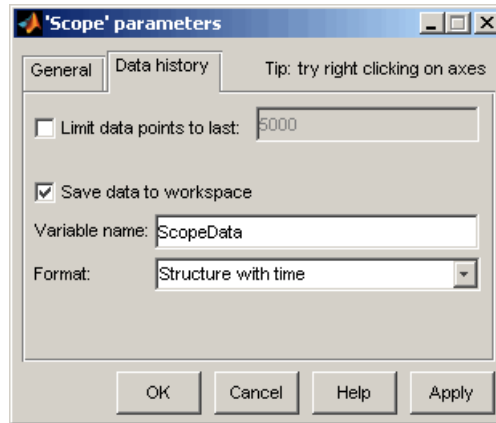

7 Do one of the following:

- Click **Apply** to apply the changes to your model and leave the dialog box open.
- Click **OK** to apply the changes to your model and close the dialog box.

When you modify anything in the Scope parameters dialog box, you must click the **Apply** or **OK** button for the changes to take effect, and you must rebuild your real-time application before connecting and starting it. If you do not rebuild, an error dialog box will open. If you do not click **Apply**, your executable will run, but it will use the old settings.

The reason why you need to rebuild is because the model checksum includes settings from the Scope block used for signal logging. If the model checksum does not match the checksum in the generated code, the real-time application cannot run. Always rebuild your real-time application after changing Scope parameters.

Entering Signal and Triggering Properties

Data is saved to the MATLAB workspace through a Simulink Scope block. Signal and triggering properties need to be set only when you are running a real-time application. If you are running a simulation, you can skip this procedure.

After you create a Simulink model and add a Scope block, you can enter the signal and triggering properties for logging to the MATLAB workspace. This

procedure uses the Simulink model `rtwin_model.mdl` as an example and assumes you have already loaded that model:

- 1** In the Simulink window, and from the **Tools** menu, click **External Mode Control Panel**.

The External Mode Control Panel dialog box opens.

- 2** Click the **Signal & Triggering** button.

The External Signal & Triggering dialog box opens.

- 3** Click the **Select all** button. From the Source list, choose `manual`. From the Mode list, choose `normal`.

The X under **Signal selection** designates that a signal has been tagged for data collection, and T designates that the signal has been tagged as a trigger signal.

- 4** In the **Duration** field, enter the number of sample points in a data buffer. For example, if you have a sample rate of 1000 samples/second and a stop time of 10 seconds, you could enter

10000

The **Duration** value is related to the **Limit data points to last** value in the Scope parameters dialog box. The smaller of either value limits the number of sample points saved to the MATLAB workspace. We recommend that you do not select the **Limit data points to last** check box; use the **Duration** value to set the number of sample points saved. To clear the **Limit data points to last** check box, see “Entering Scope Parameters” on page 3-27.

The **Duration** value specifies the number of contiguous points of data to be collected in each buffer of data. We recommend that you enter a **Duration** value equal to the total number of sample points that you need to collect rather than relying on a series of buffers to be continuous.

If you enter a value less than the total number of sample points, you will lose sample points during the time needed to transfer values from the data buffer to the MATLAB workspace. The Real-Time Windows

Target software ensures that points are continuous only within one buffer. Between buffers, because of transfer time, some samples will be omitted.

We also recommend setting the time axis for Simulink Scope blocks equal to the sample interval (in seconds) times the number of points in each data buffer. This setting will display one buffer of data across the entire Simulink Scope plot.

The External Signal & Triggering dialog box looks similar to the next figure.

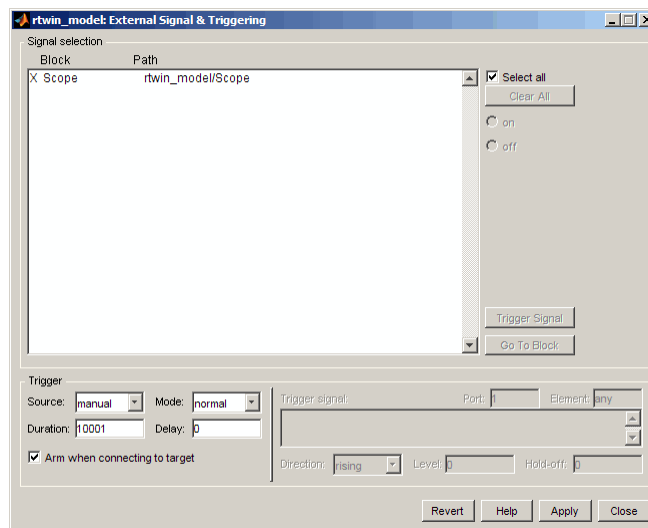

5 Do one of the following:

- Click **Apply** to apply the changes to your model and leave the dialog box open.
- Click **Close** to apply the changes to your model and close the dialog box.

You must click the **Apply** or **Close** button on the External Signal & Triggering dialog box for the changes you made to take effect. Generally it is not necessary to rebuild your real-time application.

Plotting Logged Signal Data

You can use the MATLAB plotting functions for visualizing non-real-time simulated data or real-time application data.

After running your real-time application and logging data to the MATLAB workspace, you can plot the data. This procedure uses the Simulink model `rtwin_model.mdl` as an example, and assumes you saved your data to the variable `ScopeData`.

- 1** In the MATLAB Command Window, type

```
ScopeData
```

The MATLAB Command Window shows the structure of the variable `ScopeData`. The variable `ScopeData` is a MATLAB structure containing fields for the time vector, signal structure, and a string containing the block name.

```
ScopeData =  
    time: [10000x1 double]  
  signals: [1x1 struct]  
 blockName: 'rtwin_model/Scope'
```

To list the contents of the structure `signals`, type

```
ScopeData.signals
```

The MATLAB Command Window shows the structure of the variable `ScopeData.signals`. This structure contains one or more vectors of signal data depending on the number of signal inputs to the Scope block.

```
ans =  
    values: [10000x1 double]  
 dimensions: 1  
    label: ''  
    title: []  
 plotStyle: 1
```

- 2** To plot the first 1000 points, type

```
plot(ScopeData.time(1:1000),ScopeData.signals.values(1:1000))
```

The MATLAB environment plots the first 1000 samples from 0.0000 to 0.9990 second.

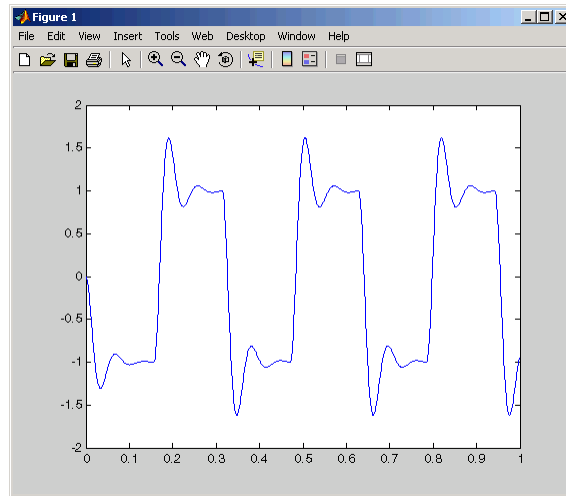

3 The variable `ScopeData` is not automatically saved to your hard disk. To save the variable `ScopeData`, type

```
save ScopeData
```

The MATLAB environment saves the scope data to the file `ScopeData.mat`.

Logging Signals to a Disk Drive

In this section...
“About Signal Logging” on page 3-34
“Entering Scope Parameters” on page 3-34
“Entering Signal and Triggering Properties” on page 3-37
“Entering Data Archiving Parameters” on page 3-39
“Plotting Logged Signal Data” on page 3-41

About Signal Logging

Logging signals to a disk drive is the process of saving (logging) data to a variable in your MATLAB workspace and then saving that data to a MAT-file on your disk drive. This allows you to use MATLAB functions for data analysis and MATLAB plotting functions for visualization.

Using the data archiving feature provided in the **External Mode Control Panel**, you can save data to a file during execution. Simulink external mode does not support data logging with Outport blocks in your Simulink model. This means you do not enter or select parameters on the **Data I/O** pane in the Configuration Parameters dialog box.

To use the data archiving feature with a Real-Time Windows Target application, you must add a Scope block to your Simulink model, and you must execute a real-time application.

Entering Scope Parameters

You save data to a disk drive by first saving the data to the MATLAB workspace through a Simulink Scope block. You need to set scope block parameters for data to be saved.

After you create a Simulink model and add a Scope block, you can enter the scope parameters for signal logging to a disk drive. This procedure uses the Simulink model `rtwin_model.mdl` as an example, and assumes you have already loaded that model.

Note If you entered the scope parameters for running a simulation, you may want to look over this procedure, because the Scope parameters dialog box is related to the External Signal & Triggering dialog box and the Data Archiving dialog box.

1 In the Simulink window, double-click the Scope block.

A Scope window opens.

2 On the toolbar, click the Parameters button.



A Scope parameters dialog box opens.

3 Click the **Data history** tab.

4 Do one of the following:

- If you are running a simulation, you can select the **Limit data points to last** check box, and enter the number of sample points to save.
- If you are running an execution, do not select the **Limit data points to last** check box.

The **Limit data points to last** check box is related to the **Duration** value in the External Signal & Triggering dialog box. The smaller of either value limits the number of sample points saved to the MATLAB workspace. When using Real-Time Windows Target software, we recommend that you use the **Duration** value to set the number of sample points you save. To set the **Duration** value, see “Entering Signal and Triggering Properties” on page 3-37.

5 Select the **Save data to workspace** check box. In the **Variable name** text box, enter the name of a MATLAB variable. The default name is ScopeData.

The Scope parameters dialog box is related to the Data Archiving dialog box. In the Scope parameters dialog box, you must select the **Save data to workspace** check box to be able to save data to a disk drive, for two reasons:

- The data is first transferred from the data buffer to the MATLAB workspace before being written to a MAT-file.
- The **Variable name** entered in the Scope parameters dialog box is the same as the one in the MATLAB workspace and the MAT-file.

If you do not select the **Save data to workspace** check box, the MAT-files for data logging will be created, but they will be empty.

- 6 From the Format list, choose either Structure with time, Structure, or Array(compatible with Version 2.0 through Version 2.2). For example, to save the sample times and signal values at those times, choose Structure with time. Your **Data history** pane looks similar to the next figure.

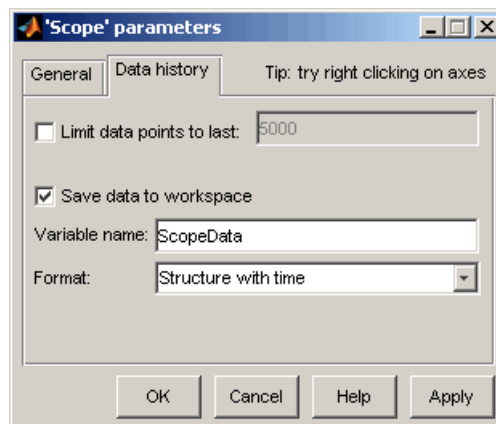

- 7 Do one of the following:
 - Click **Apply** to apply the changes to your model and leave the dialog box open.
 - Click **OK** to apply the changes to your model and close the dialog box.

You must rebuild your real-time application before connecting and starting the application with changed settings. If you do not rebuild after making changes, an error will occur.

Entering Signal and Triggering Properties

Data is saved to a disk drive by first saving the data to the MATLAB workspace through a Simulink Scope block. Signal and triggering properties need to be set when running a real-time application.

After you create a Simulink model and add a Scope block, you can enter the signal and triggering properties for data logging to a disk drive. This procedure uses the Simulink model `rtwin_model.mdl` as an example, and assumes you have already loaded that model:

- 1 In the Simulink window, and from the **Tools** menu, click **External Mode Control Panel**.

The External Mode Control Panel dialog box opens.

- 2 Click the **Signal & Triggering** button.

The External Signal & Triggering dialog box opens.

- 3 Click the **Select all** button. From the Source list, choose `manual`. From the Mode list, choose `normal`.

The X under **Signal selection** designates that a signal has been tagged for data collection, and T designates that the signal has been tagged as a trigger signal.

- 4 In the **Duration** field, enter the number of sample points in a data buffer. For example, if you have a sample rate of 1000 samples/second and a stop time of 10 seconds, then enter

10000

The **Duration** value is related to the **Limit data points to last** value in the Scope parameters dialog box. The smaller of either value limits the number of sample points saved to the MATLAB workspace. We recommend that you do not select the **Limit data points to last** check box, and use the **Duration** value to set the number of sample points saved.

The **Duration** value specifies the number of contiguous points of data to be collected in each buffer of data. We recommend that you enter a **Duration** value equal to the total number of sample points you need to collect for a run. If you enter a value much less than the total number of sample points, you may lose logging sample points due to the time needed to transfer values from the data buffer to the MATLAB workspace.

We also recommend setting the time axis for Simulink Scope blocks equal to the sample interval (in seconds) times the number of points in each data buffer. This setting will display one buffer of data across the entire Simulink Scope plot.

The External Signal & Triggering dialog box looks similar to the next figure.

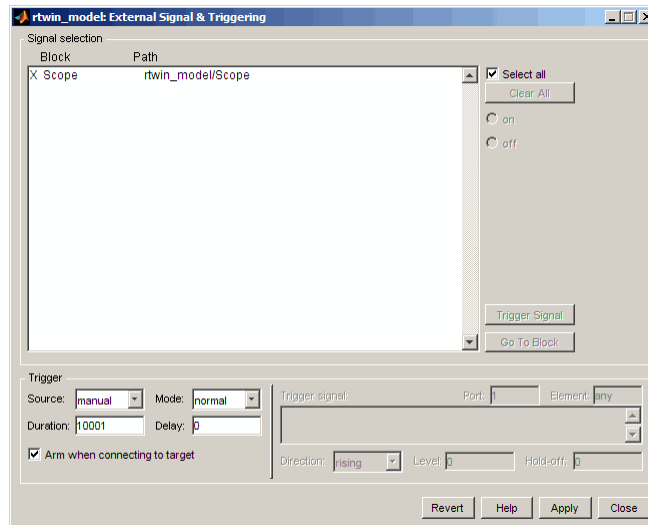

5 Do one of the following:

- Click **Apply** to apply the changes to your model and leave the dialog box open.
- Click **Close** to apply the changes to your model and close the dialog box.

You must click the **Apply** or **Close** button on the External Signal & Triggering dialog box for the changes you made to take effect, but you do not have to rebuild your real-time application.

Entering Data Archiving Parameters

The Data Archiving dialog box is related to the Scope parameters dialog box. In the Scope parameters dialog box, you must select the **Save data to workspace** check box to be able to save data to a disk drive, for two reasons:

- The data is first transferred from the scope data buffer to the MATLAB workspace before being written to a MAT-file.
- The **Variable name** entered in the Scope parameters dialog box is the same as the one in the MATLAB workspace and the MAT-file. Enabling the data to be saved enables a variable named with the **Variable name** parameter to be saved to a MAT-file.

If you do not select the **Save data to workspace** check box in the Scope parameters dialog box, the MAT-files for data logging will be created, but they will be empty.

After you create a Simulink model, you can enter the Data Archiving Parameters for data logging to a disk drive:

- 1 In the Simulation window, and from the **Tools** menu, click **External Mode Control Panel**.

The External Mode Control Panel dialog box opens:

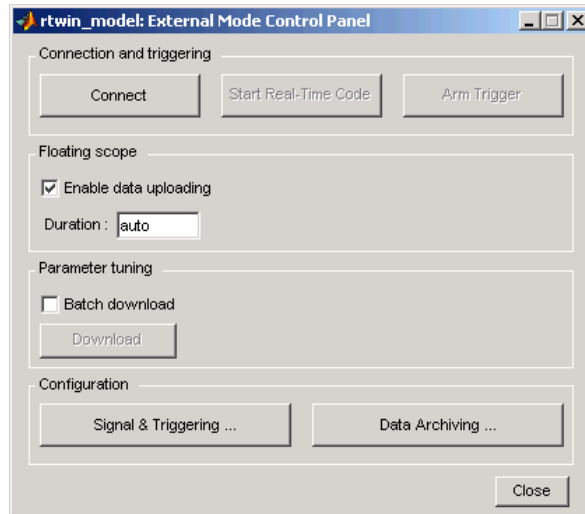

- 2 Click the **Data Archiving** button.

The External Data Archiving dialog box opens. This dialog box allows you to specify data archiving options.

- 3 Select the **Enable archiving** check box.

- 4 In the **Directory** text box, enter the path to a directory on your disk drive. For example, if your MATLAB working directory is named `mwd`, enter

```
c:\mwd
```

- 5 In the **File** text box, enter the file name prefix for the data files to be saved. For example, enter

```
data
```

The MATLAB environment names the files `data_0.mat`, `data_1.mat`, etc. The number of files equals the total sample points. For example, if you set **Duration** to `Total sample points`, then only one file is created.

- 6 Select the **Append file suffix to variable names** check box.

Within each MAT-file, a variable is saved with the same name you entered in the **Variable name** text box (**Data history** pane on the Scope parameters dialog box). By selecting the **Append file suffix to variable names** check box, the same suffix that is added to the MAT-file is added to the variable name. For example, if you entered the variable name `ScopeData`, then within the file `data_0.mat` will be a variable `ScopeData_0`.

Your External Data Archiving dialog box looks similar to the next figure.

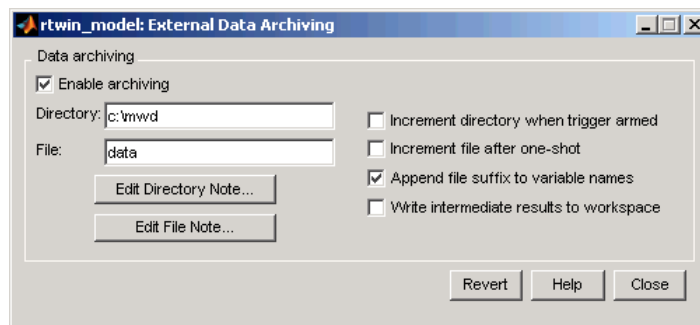

7 Click the **Close** button.

The parameters you entered are applied to your model.

There is no **Apply** button with this dialog box. You must click the **Close** button for the changes you make to take effect.

Plotting Logged Signal Data

You can use the MATLAB plotting functions for visualization of your non-real-time simulated data or your real-time executed data.

After running your real-time application and logging data to a disk drive, you can plot the data. This procedure uses the Simulink model `rtwin_model.mdl` as an example, and assumes you saved your data to the variable `ScopeData`:

1 In the MATLAB Command Window, type

```
ScopeData
```

The MATLAB Command Window shows the structure of the variable `ScopeData`. The variable `ScopeData` is a MATLAB structure containing the fields time vector, signal structure, and a string containing the block name.

```
ScopeData =  
    time: [10000x1 double]  
  signals: [1x1 struct]  
  blockName: 'rtwin_model/Scope'
```

- 2** To list the MAT-files saved to your disk drive, type

```
dir *.mat
```

The MATLAB Command Window shows the MAT-files in your current working directory.

```
ScopeData.mat
```

- 3** To clear the MATLAB workspace and load the scope data, type

```
clear  
load ScopeData  
who
```

The MATLAB Command Window displays:

```
Your variables are:  
ScopeData
```

- 4** To plot the first 1000 points, type

```
plot(ScopeData.time(1:1000), ScopeData_0.signals.values(1:1000))
```

The MATLAB environment plots the first 1000 samples from 0.0000 to 0.9990 second.

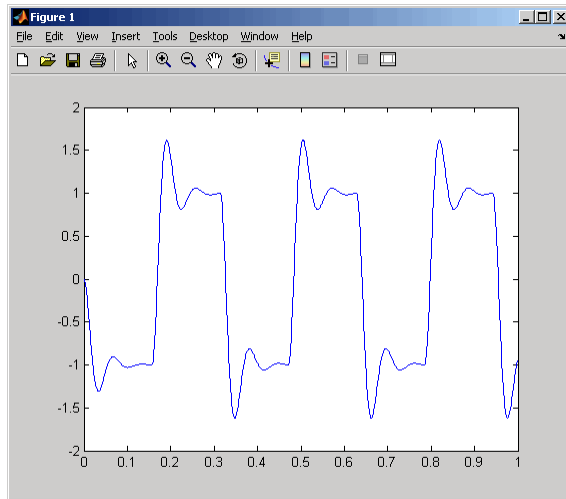

Tuning Parameters

In this section...
“About Parameter Tuning” on page 3-44
“Changing Model Parameters” on page 3-45

About Parameter Tuning

Simulink external mode connects your Simulink model to your real-time application. The block diagram becomes a graphical user interface to the real-time application. You can change parameter values while running the real-time application by changing the values in

- **Block parameters** — Change block parameters by changing the values in the dialog boxes associated with the Simulink blocks. Once you change a value, and click **OK**, the new value is downloaded to the real-time application.

Note Opening a dialog box for a source block causes Simulink to pause. While Simulink is paused, you can edit the parameter values. You must close the dialog box to have the changes take effect and allow Simulink to continue.

- **MATLAB variables** — Change MATLAB variables by entering the changes through the MATLAB command line, and then press **Ctrl+D** for the changes to be downloaded to your executable. An alternative method to download parameters is to click **Update Diagram** from the **Edit** menu in your Simulink window. Simply changing the value of the MATLAB variable at the MATLAB command line is not sufficient for the Simulink software to know that the value has changed.

Simulink external mode also supports side-effects functions. For example, given an expression in a Gain block of $2*a+b$, the expression is evaluated and the resulting value is exported to the real-time application during execution.

When a parameter in a Simulink model is changed, the communication module `rtwinext.mex*` transfers the data to the external real-time application and changes the model parameters. Only the parameters that do not result in model structure modification can be changed. If the structure is modified, you must recompile the model. Model structure changes are detected automatically using model checksum and reported to the MATLAB Command Window to avoid conflicts.

Changing Model Parameters

You must use Simulink external mode to change model parameters. While external mode is running, you can open Simulink blocks and change parameter values. External mode will transfer the new value to the real-time application.

Note Opening a dialog box for a source block causes Simulink to pause. While Simulink is paused, you can edit the parameter values. You must close the dialog box to have the changes take effect and allow Simulink to continue.

After you start running your real-time application, you can change parameters and observe the changes to the signals. To start a real-time application, see “Running a Real-Time Application” on page 3-23.

The following procedure uses the Simulink model `rtwin_model.mdl` as an example. It assumes you have created a real-time application and are executing it.

- 1 From the **Simulation** menu, click **Start Real-Time**.

The real-time execution starts running and signal data is displayed in the Scope window.

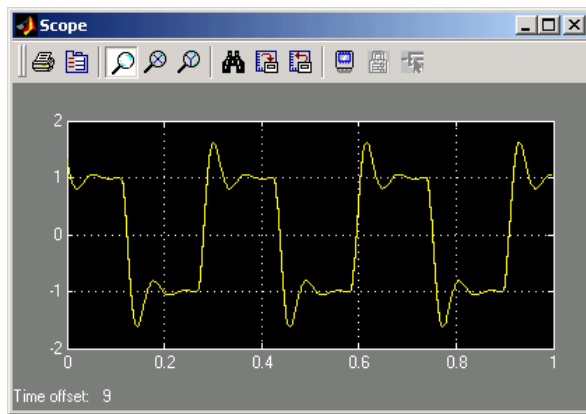

2 From the Simulink block diagram, double-click the Transfer Function block.

The Block Parameters: Transfer Fcn dialog box opens:

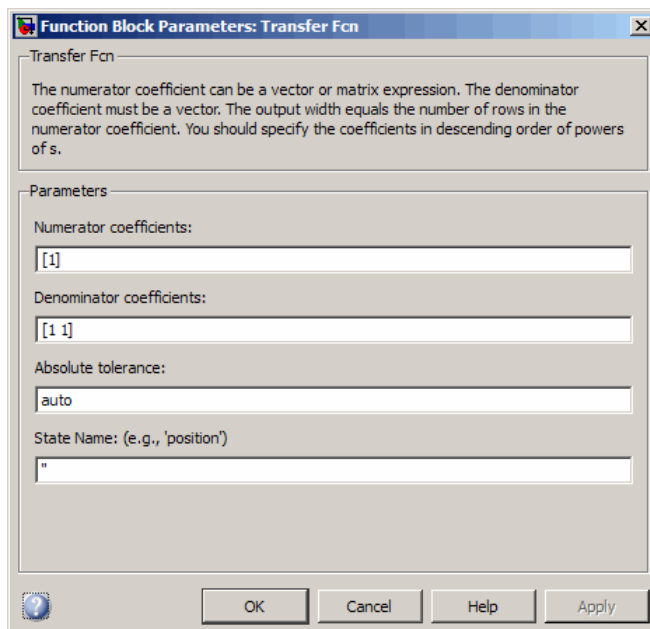

3 In the **Denominator** field, change 70 to 30. Click **OK**.

The effect of changing a block parameter is shown in the Scope window.

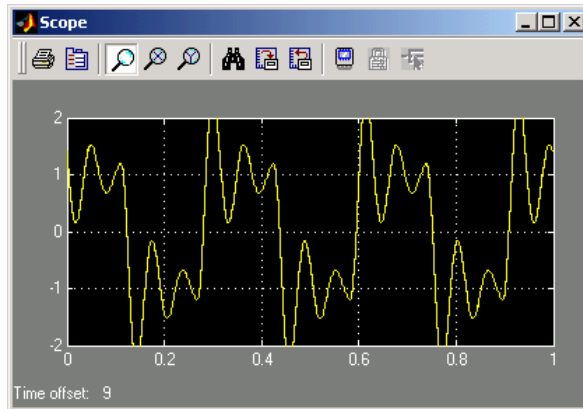

Boards, Blocks, and Drivers

- “Introduction” on page 4-2
- “Using I/O Boards” on page 4-3
- “Using I/O Driver Blocks” on page 4-10
- “Using Analog I/O Drivers” on page 4-16
- “Using Vector CAN Drivers” on page 4-21

Introduction

Real-Time Windows Target software includes driver blocks for more than 200 I/O boards. These driver blocks connect the physical world to your real-time application.

Using I/O Boards

In this section...

“About I/O Boards” on page 4-3

“Installing and Configuring I/O Boards and Drivers” on page 4-3

“ISA Bus Board” on page 4-7

“PCI Bus Board” on page 4-7

“PC/104 Board” on page 4-8

“Compact PCI Board” on page 4-8

“PCMCIA Board” on page 4-9

About I/O Boards

Typically I/O boards are preset from the factory for certain base addresses, voltage levels, and unipolar or bipolar modes of operation. Boards often include switches or jumpers that allow you to change many of these initial settings. For information about setting up and installing any I/O board, read the board manufacturer’s documentation.

For an online list of all I/O boards that Real-Time Windows Target software supports, see Supported I/O Boards.

Installing and Configuring I/O Boards and Drivers

A Real-Time Windows Target model connects to a board by including an I/O driver block. This block provides an interface to the board’s device driver and all board-specific settings. The device drivers included with the Real-Time Windows Target software usually provide the same flexibility of settings offered by the board manufacturer. You can enter I/O board settings by using the I/O Block Parameters dialog box; setting jumpers and switches on the board; or both. The three types of board settings are:

- **Software selectable** — Specify the desired settings in the I/O Block Parameters dialog box. The driver writes the settings you specify to the board. Examples include A/D gain inputs and selecting unipolar or bipolar D/A outputs.

- **Hardware selectable and software readable** — Specify the desired settings by configuring jumpers or switches on the board. The driver reads the settings you selected and displays them in the I/O Block Parameters dialog box.
- **Hardware selectable, but not software readable** — Set jumpers or switches on the physical board, and then enter the same settings in the I/O Block Parameters dialog box. These entries must match the hardware jumpers or switches you set on the board. This type of setting is necessary when the board manufacturer does not provide a means for the I/O driver to write or read all board settings. Examples include base address, D/A gain, and differential or single-ended A/D inputs.

You can configure a Real-Time Windows Target model to use an I/O board whether or not the board exists in the computer, but you will not be able to run the model until the board is installed with any jumpers or switches correctly set. Details of installation and configuration depend on the data transfer direction and the specific board, but are essentially similar in all cases. Details for various types of boards and drivers appear later in this chapter.

The following instructions use the Humusoft® AD512 I/O board as an example, configure the board for analog input, and assume that you have physically configured and installed the board in your computer before you add its driver to your model. Customize the steps to provide the results that you need.

To install and configure an I/O board and its driver,

- 1** Install the board in the computer, setting any jumpers or switches as needed.
- 2** In the model window, choose **View > Library Browser** to display the Simulink Library Browser.
- 3** Clone an appropriate Input or Output driver block to your model from the Real-Time Windows Target library.
- 4** Double-click the cloned I/O driver block.

The I/O Block Parameters dialog box opens. For an Analog Input block, the dialog box initially looks like this:

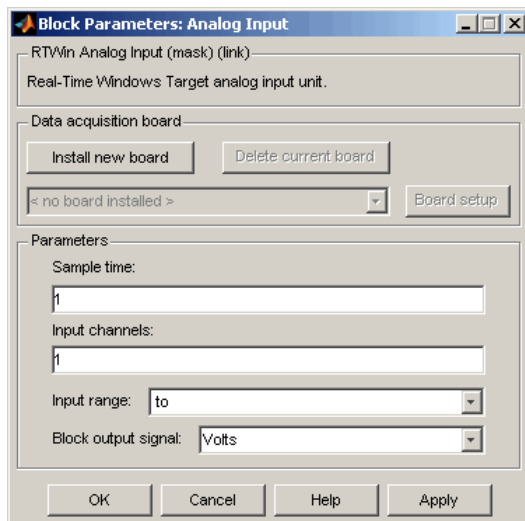

- 5 Click **Install new board**. From the list that appears, point to a manufacturer, then select a board type. For example, point to **Humusoft**, then click **AD512**:

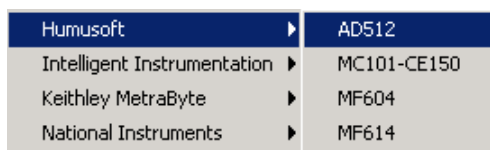

The I/O board dialog box opens. The name of this dialog box depends on which I/O board you selected. The box for the Humusoft AD512 board looks like this:

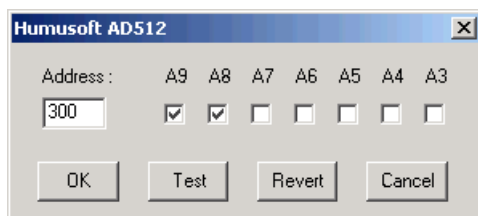

- 6 Select one of the following, as appropriate to the board:

- For an ISA bus board, enter a hexadecimal base address. This value must match the base address jumpers or switches set on the physical board. For example, to enter a base address of 0x300, in the **Address** box type

300

You can also select the base address by checking boxes **A9** through **A3**.

- For a PCI bus board, enter the **PCI slot** or check **Auto-detect**.

7 The I/O Block Parameters dialog also lets you set other I/O block parameters, such as the sample time. Set such parameters as needed.

8 Click **Test**.

The Real-Time Windows Target kernel tries to connect to the selected board, and if successful, displays the following message.

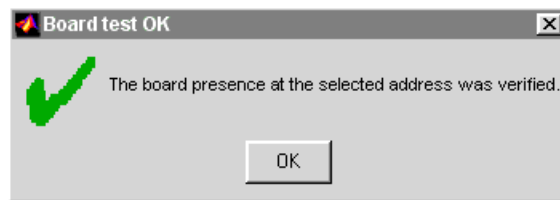

9 Click **OK** on the message box, and again on the I/O Block Parameters dialog box.

The I/O Block Parameters dialog box closes, and the parameter values are included in your Simulink model.

Multiple Boards of Identical Type

When multiple boards of identical type exist, you must execute the complete installation sequence for each board, just as you would if the boards were of different types. Thus two identical PCI boards would result in two entries in the drop-down list of installed boards. The entries would differ only in the PCI slot number shown for each board.

Autodetecting Multiple Boards. The Autodetect feature cannot be used to locate multiple boards of the same type. You must specify their PCI slot numbers manually.

Multiple Driver Blocks for One Board

Once you have used the I/O Block Parameters dialog box to add a board and configure its driver, you can add additional I/O driver blocks that connect to the same board from other locations in the model. To accomplish this, clone the appropriate driver block, open its I/O Block Parameters dialog box, and choose the board from the list of installed boards.

Scope of Driver Block Parameters. All I/O driver blocks that use a given board share identical parameters. You need to specify these parameters only once, when you first add the board and configure its driver. If you subsequently change a parameter in any driver block connected to a board, the same change occurs in all the other driver blocks connected to that board.

ISA Bus Board

Most ISA bus I/O boards are preset with a base address of 0x300. If you are using multiple I/O boards or other boards (for example, network cards) that already use the address 0x300, you must set your board with another base address.

In the I/O board dialog box, enter the same base address that you set on the physical board. You open the I/O board dialog box from any I/O driver Block Parameters dialog box.

PCI Bus Board

You do not have to set a base address with a PCI board. The plug-and-play feature of the Windows operating system assigns a PCI slot number. You can enter the slot number in the I/O board dialog box, or you can let the driver determine the slot number for you. You open the I/O board dialog box from any I/O driver Block Parameters dialog box.

We recommend that before you use a PCI or PCMCIA board, you install the drivers supplied by the board manufacturer. The Real-Time Windows Target software does not use these manufacturer-supplied drivers. However, they

sometimes initiate the plug-and-play recognition of the board. Without these drivers installed, the board might be invisible to your computer and to the Real-Time Windows Target software.

Writing PCI Bus Board Drivers

Real-Time Windows Target applications cannot use Windows DLLs and kernel-mode drivers, which are not suitable for real-time operation. The device drivers supported by the Real-Time Windows Target software are listed at Supported I/O Boards. If no driver is listed for the board that you want to use, you may be able to write a custom device driver.

A user-written custom device driver must program the board directly at the register level, which is the technique used by all supported Real-Time Windows Target drivers. If the board registers are I/O-mapped, the Real-Time Windows Target software supports such programming. If the registers are memory-mapped, programming them would require mapping their memory region to Real-Time Windows Target address space, which the Real-Time Windows Target software does not support for user-written drivers.

If you want to use an unsupported board that you believe should be supported, or you need assistance with user-written Real-Time Windows Target device drivers, including the case of a board with memory-mapped registers, contact The MathWorks Technical Support.

PC/104 Board

Most PC/104 bus I/O boards are preset with a base address of 0x300. If you are using multiple I/O boards or other boards (for example, network cards) that already use the address 0x300, you must set your board with another base address.

In the I/O board dialog box, enter the same base address that you set on the physical board. You open the I/O board dialog box from any I/O driver Block Parameters dialog box.

Compact PCI Board

Using a compact PCI board requires that you use a compact PC (industrial PC). In addition, you need to install the Windows operating system, the

MATLAB environment, Simulink software, and Real-Time Windows Target software on the compact PC.

PCMCIA Board

The plug-and-play feature of the Windows operating system assigns a base address automatically. You can enter this address in the I/O board dialog box, or you can let the driver determine the address for you. You open the I/O board dialog box from any I/O driver Block Parameters dialog box.

We recommend that before you use a PCI or PCMCIA board, you install the drivers supplied by the board manufacturer. Real-Time Windows Target software does not use these manufacturer-supplied drivers. However, they sometimes initiate the plug-and-play recognition of the board. Without these drivers installed, the board might be invisible to your computer and to the Real-Time Windows Target software.

Using I/O Driver Blocks

In this section...
“About I/O Driver Blocks” on page 4-10
“The Real-Time Windows Target Library” on page 4-10
“Output Signals from an I/O Block” on page 4-11
“Variations with Channel Selection” on page 4-12

About I/O Driver Blocks

Real-Time Windows Target I/O driver blocks allow you to select and connect specific analog channels and digital lines to your Simulink model through I/O driver blocks. These blocks provide an interface to your physical I/O boards and your real-time application. They ensure that the C code created by Real-Time Workshop code generation software correctly maps block diagram signals to the appropriate I/O channels. All I/O blocks support all applicable Simulink datatypes.

You can have multiple I/O blocks associated with each type of I/O board. For example, you can have one Analog Input block for channels 1 to 4 and another block for channels 5 to 8. Each I/O block in a model specifies its own block configuration parameters, which apply only to that instance of that block. See “Blocks — Alphabetical List” for a description of the configuration parameters for each I/O block.

The Real-Time Windows Target Library provides blocks that you can use with supported I/O boards. You can also create your own I/O blocks to work with Real-Time Windows Target software. See Appendix A, “Custom I/O Driver Blocks” for details.

The Real-Time Windows Target Library

All Real-Time Windows Target I/O driver blocks are available in the Real-Time Windows Target Library. To view this library from the MATLAB Command Window, type:

```
rtwinlib
```

To view the Real-Time Windows Target Library from a model:

- 1 In the model window, choose **View > Library Browser**.

The Simulink Library Browser opens. The left pane shows a hierarchy of libraries and categories, with the Simulink library at the top. The right pane shows the blocks available in the category selected on the left. See “Library Browser” for more information.

- 2 In the left column, double-click **Real-Time Windows Target**.

The Real-Time Windows Target library opens.

You can add any I/O block in the library to your Simulink model by dragging it from the library to the model. After you add the block, connect it to your model as you would any other block, and provide block configuration parameter values as described for the block in “Blocks — Alphabetical List”.

Output Signals from an I/O Block

I/O driver blocks output multiple signals as a vector instead of individual channels or lines. To connect the individual channels and lines to parts of your Simulink model, you need to separate the vector with a **Demux** block.

After you add and configure an I/O driver block in your Simulink model, you can separate and connect the output signals from the blocks:

- 1 In the Simulink window, choose **View > Library Browser**.

The Simulink Library Browser opens.

- 2 In the **Simulink** library, click **Signal Routing**. From the list in the right pane, click and drag **Demux** to your Simulink model.
- 3 Double-click the Demux block. The Block Parameters: Demux dialog box opens. Enter the number of lines leaving the Demux block. For example, if you entered three channels in the Analog Input driver block, enter 3 in the **Number of outputs** box.

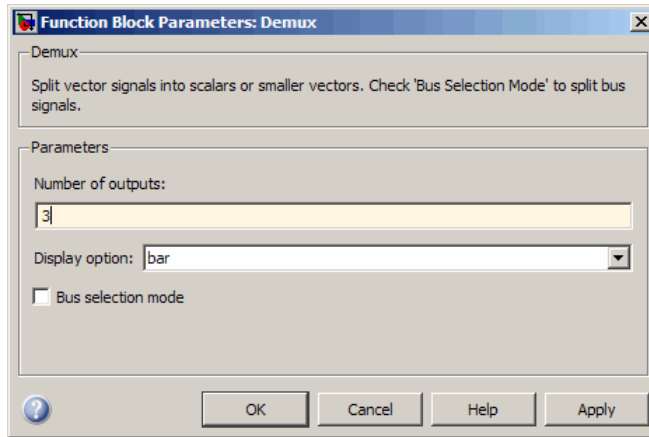

4 Click **OK**.

5 Finish making connections and selecting display options.

- Connect the Analog Input block to the Demux block input.
- Connect each of the Demux block output lines to the input of other blocks.
- In the Simulink window, and from the **Format** menu, click **Port/Signal Displays > Wide Nonscalar Lines**, and click **Signal Dimensions**.

In this simple example, inputs 1 and 2 are not connected, but they could be connected to other Simulink blocks.

Variations with Channel Selection

For a better understanding of how to specify device settings when using both analog and digital signals, this section uses the Keithley® Metrabyte™ DAS-1601 I/O board as an example. The following is a specification summary of the DAS-1601 board:

- **Analog input (A/D)** — 16 single-ended or 8 differential analog inputs (12-bit), polarity is switch configured as either unipolar (0 to 10 volts) or bipolar (+/- 10 volts). Gain is software configured to 1, 10, 100, and 500.
- **Digital input** — Four unidirectional digital inputs
- **Analog output (D/A)** — Two analog outputs (12-bit). Gain is switch configured as 0 to 5 volts, 0 to 10 volts, +/- 5 volts, or +/- 10 volts

- **Digital output** — Four unidirectional digital outputs
- **Base address** — Switch configured base address

This section explores different configurations for input signals.

Once an Analog Input block has been placed in the model and the I/O board selected and configured, you can set up the Analog Input block to handle input signals.

Single analog input — The most basic case is for a single analog input signal that will be physically connected to the first analog input channel on the board. In the Block Parameter: Analog Input dialog box, and the **Input channels** box, enter

1 or [1]

The use of brackets is optional for a single input.

Input vector with differential analog — Analog channels are numbered starting with channel 1 and continue until you reach a number corresponding to the maximum number of analog signals supported by the I/O board.

In the case of the DAS-1601, when configured as differential inputs, eight analog channels are supported. The analog input lines are numbered 1 through 8. The complete input vector is

[1 2 3 4 5 6 7 8] or [1:8]

If you want to use the first four differential analog channels, enter

[1 2 3 4]

Input vector with single-ended analog — Now, assume your DAS-1601 board is configured to be single-ended analog input. In this case, 16 analog input channels are supported. The complete input vector is

[1 2 3 4 5 6 7 8 9 10 11 12 13 14 15 16] or [1:16]

To use the first four single-ended analog input channels, enter

[1 2 3 4] or [1:4]

The next figure shows the resulting block diagram.

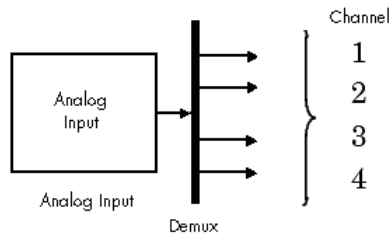

We do not recommend specifying more channels than you actually use in your block diagram. This results in additional overhead for the processor with A/D or D/A conversions. In this case, for example, even though some channels are not actually used in the block diagram, these channels are still converted.

You could attach terminator blocks to channels 4 and 5 inside your block diagram after passing the Analog Input block vector in to a Demux block. Adding terminator blocks provides you with graphical information in your block diagram to clearly indicate which channels you connected and which are available. The penalty is that even the terminated channels are converted, adding some computational overhead.

The next figure shows the block implementation.

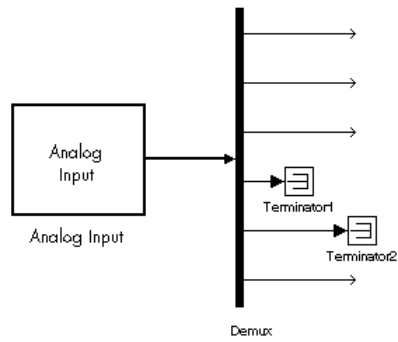

Depending on the board and the number of channels used, I/O conversion time can affect the maximum sample rate that can be achieved on your system. Rather than converting unused channels, we recommend specifying only the set of channels that are actually needed for your model.

Using Analog I/O Drivers

In this section...
“About Analog Drivers” on page 4-16
“I/O Driver Characteristics” on page 4-16
“Normalized Scaling for Analog Inputs” on page 4-17

About Analog Drivers

Control systems have unique requirements for I/O devices used with Real-Time Windows Target applications. For information about writing custom I/O device drivers to work with Real-Time Windows Target applications, see Appendix A, “Custom I/O Driver Blocks”.

I/O Driver Characteristics

Real-Time Windows Target applications use off-the-shelf I/O boards provided by many hardware vendors. These boards are often used for data acquisition independently of Real-Time Windows Target software. In such environments, board manufacturers usually provide their own I/O device drivers for data acquisition purposes. This use differs significantly from the behavior of drivers provided with Real-Time Windows Target software.

In data acquisition applications, data is often collected in a burst or frame consisting of many points, perhaps 1,000 or possibly more. The burst of data becomes available once the final point is available. This approach is not suitable for use in automatic control applications, because it results in unacceptable latency for most or all data points.

In contrast, drivers used by Real-Time Windows Target applications capture a single point of data at each sample interval. Considerable effort is made to minimize the latency between collecting a data point and using the data in the control system algorithm. This is the reason why a board that specifies a maximum sample rate (for data acquisition) might be described as achieving sample rates well in excess of the rates that are achievable by Real-Time Windows Target applications. For data acquisition, such boards usually acquire data in bursts and not in a point-by-point fashion, which is more appropriate for stable control systems.

Normalized Scaling for Analog Inputs

Real-Time Windows Target software allows you to normalize I/O signals internal to the block diagram. Generally, inputs represent real-world values such as angular velocity, position, temperature, pressure, and so on. This ability to choose normalized signals allows you to

- Apply your own scale factors
- Work with meaningful units without having to convert from voltages

When using an Analog Input block, you select the range of the external voltages that are received by the board, and you choose the block output signal. For example, the voltage range could be set to 0 to +5 V, and the block output signal could be chosen as Normalized unipolar, Normalized bipolar, Volts, or Raw.

If you prefer to work with units of voltage within your Simulink block diagram, you can choose Volts.

If you prefer to apply your own scaling factor, you can choose Normalized unipolar or Normalized bipolar, add a Gain block, and add an offset to convert to a meaningful value in your model.

If you prefer unrounded integer values from the analog-to-digital conversion process, you can choose Raw.

0 to +5 Volts and Normalized Bipolar

From the Input range list, choose 0 to +5 V, and from the Block output signal list, choose Normalized bipolar. This example converts a normalized bipolar value to volts, but you could also easily convert directly to another parameter in your model.

```
0 to 5 volts --> ([-1 to 1] normalized + 1) * 2.5
```

In your block diagram, you can do this as follows.

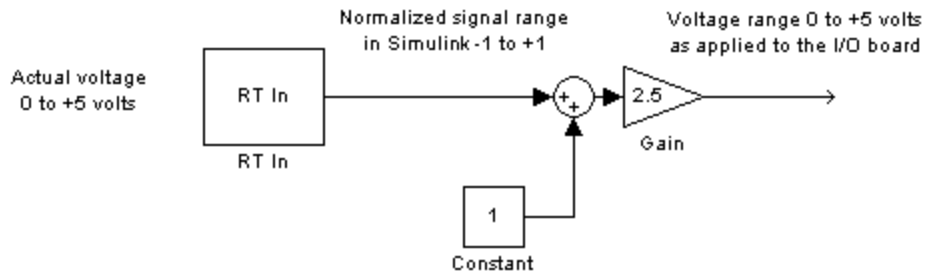

0 to +5 Volts and Normalized Unipolar

From the Input range list, choose 0 to +5 V, and from the Block output signal list, choose Normalized unipolar. This example converts a normalized unipolar value to volts, but you could also easily convert directly to another parameter in your model.

0 to 5 volts --> ([0 to 1] normalized * 5.0)

In your block diagram, you can do this as follows.

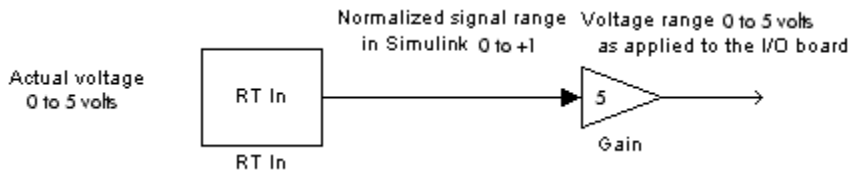

-10 to +10 Volts and Normalized Bipolar

From the Input range list, choose -10 to +10 V, and from the Block output signal list, choose Normalized bipolar. This example converts a normalized bipolar value to volts, but you could also easily convert directly to another parameter in your model.

-10 to 10 volts --> [-1 to +1] normalized * 10

In your block diagram, you can do this as follows.

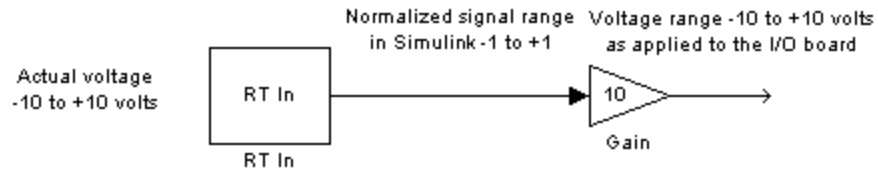

-10 to +10 Volts and Normalized Unipolar

From the Input range list, choose -10 to +10 V, and from the Block output signal list, choose Normalized unipolar. This example converts a normalized bipolar value to volts, but you could also easily convert directly to another parameter in your model.

$$-10 \text{ to } 10 \text{ volts} \rightarrow ([0 \text{ to } 1] \text{ normalized} - 0.5) * 20$$

In your block diagram, do this as follows.

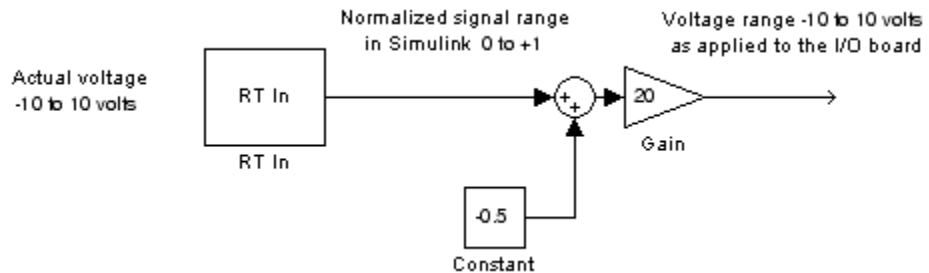

Normalized Scaling for Analog Outputs

Analog outputs are treated in an equivalent manner to analog inputs.

If the voltage range on the D/A converter is set to 0 to +5 volts, and the Block input signal is chosen as Normalized bipolar, then a Simulink signal of amplitude -1 results in an output voltage of 0 volts. Similarly, a Simulink signal of amplitude +1 results in an output voltage of +5 volts.

A voltage range on the D/A converter is set to -10 to +10 volts, and the Block input signal is chosen as Normalized bipolar, then a Simulink signal of amplitude -1 results in an output voltage of -10 volts. Similarly, a Simulink signal of amplitude +1 results in an output voltage of +10 volts.

This may require that you adjust your signal amplitudes using a Gain block, Constant block, and Summer block depending on the selected voltage range.

Using Vector CAN Drivers

Before you can use the Vector Informatik CAN devices, you must install the drivers for them.

1 Install the Vector CAN devices. See the Vector Informatik GmbH documentation for installation instructions for hardware devices such as CANcaseXL, CANboardXL, and CANcardXL, drivers, support libraries, and so on.

2 Ensure that you have the Vector XL driver library for the Windows XP or Windows Vista™ system. If you do not have this library, download it Vector Informatik GmbH Web site:

https://www.vector-worldwide.com/va_downloadcenter_us.html

3 Install the driver file.

4 Copy the vxlapi.dll file into the Windows system root\system32 directory.

5 Use the Vector software to assign physical CAN channels to an application. When specifying the name for the Real-Time Windows Targets application, use the string MATLAB.

Troubleshooting

- “Introduction” on page 5-2
- “Building Older Models” on page 5-3
- “Plots Not Visible in Simulink Scope Block” on page 5-4
- “Failure to Connect to Target” on page 5-5
- “Scope Output Delayed or Missing” on page 5-6
- “S-Functions Using Math Functions” on page 5-7

Introduction

Solutions have been worked out for some common errors and problems that can occur when you are using Real-Time Windows Target software.

Building Older Models

If you are building an older model with Real-Time Windows Target software, you might get a message like the following:

```
"Real-Time Workshop utilizes device specific information (e.g.,  
microprocessor word sizes) to reproduce a bit true representation  
of the diagram. This information is not specified in this model.  
If you continue, Real-Time Workshop will use a 32-bit generic  
target setting."
```

This is simply a warning, and you can ignore the message. To eliminate this message, you can use the `rtwinconfigset` command, as follows:

```
rtwinconfigset('<model_name>')
```

Plots Not Visible in Simulink Scope Block

For data to plot correctly in a Simulink Scope block, you must specify the following:

- **External mode** selected from the **Simulation** menu in the Configuration Parameters dialog
- **Connect to target** selected from the **Simulation** menu
- Select one or more signals for capture (designated with "X") in the External Signal & Triggering dialog box from the **Tools > External Mode Control Panel** menu.
- **Duration * Fixed Step Size** close to or less than the X range in the Scope block
- Correct mode (one-shot vs. normal)
- Appropriate signal levels to allow triggering
- Y range on Simulink Scope block axes large enough to span the signal amplitude
- X range
- **Arm when connect to target** in the External Signal & Triggering dialog box or **Arm Trigger** in the **External Mode Control Panel**
- **Start real-time code** selected from the **Simulation** menu

If you are unable to see signals plotted in your Simulink Scope blocks after all of the above items have been selected, your system might have insufficient CPU time. To determine CPU utilization, type `rtwho`. The `rtwho` command returns information about MATLAB performance. The value returned is an indicator of how much loading your model places on the CPU. If Scope blocks fail to plot, this can be an indication that insufficient time is available between sample intervals to allow data to be transferred back to the MATLAB environment where the plotting is performed. To test for this condition, you can run one of the demonstration models, or you can try running your model at a significantly slower rate to determine whether this is the cause. We recommend that MATLAB performance not fall below 80%.

Failure to Connect to Target

Possible Problem — When trying to connect to the target, the Simulation Errors dialog box displays

```
Checksum mismatch. Target code needs to be rebuilt.
```

Solution — This indicates that the model structure has changed since the last time code was generated. You must rebuild the real-time application. If your model fails to build successfully, we recommend that you delete `.mk` and `.obj` files from the Real-Time Workshop project directory, and then select **Build** from the **Tools** menu.

Possible Problem — When trying to connect to the target, the Simulink Diagnostic dialog box displays

```
External mode MEX-file "win_tgt" does not exist or is not on the  
MATLAB path.
```

Solution — Versions 1.0 and 1.5 of the Real-Time Windows Target software used the MEX-file `win_tgt`. For Version 2.2 and later, the MEX-file name was changed to `rtwinext`. If you create a new Simulink model, the new filename is entered correctly. If you have a Simulink model where you used Version 1.0 or 1.5, you need to change the filename using the following procedure:

- 1** In the Simulink window, from the **Tools** menu, click **External Mode Control Panel**.
- 2** On the External Mode Control Panel dialog box, click the **Target interface** button.
- 3** In the **MEX-file for external mode** text box, enter

```
rtwinext
```
- 4** Click **OK**.

Scope Output Delayed or Missing

During a run, you may notice either slow updates of Scope blocks or a complete failure to plot data in Scope blocks. This could indicate that the real-time application sample time (set by **Configuration Parameters > Fixed step size**) is near the lower threshold for your hardware. Plotting data has a lower priority than executing the application, so a small sample time may allow the application to run but leave insufficient resources for plotting. If the sample time is so small that the application itself cannot run, an error message is displayed and real-time execution is terminated.

To check the appropriateness of the sample time, type `rtwho`, then look at the value displayed for MATLAB performance. A value less than 80% indicates that your sample time may be too small. If this occurs, select a larger sample time. If necessary, also change the sample time of any I/O drivers to be the same as the new application sample time, or an integer multiple of that time. Then rebuild the model, connect to the target, and restart the real-time application.

You may need to iterate changing the sample time until scope output appears. You must always rebuild the application after changing the sample time. In general, we recommend that you start by choosing a larger sample time, then decreasing it as needed to provide the desired responsiveness and accuracy. For example, initially select a sample time of 0.01 second, and confirm that your system runs correctly and plots are displayed.

Sample times can be too large as well as too small. After you have found an application sample time that gives acceptable Scope block display, again type `rtwho` and check MATLAB performance. If MATLAB performance is in the range of 98% or so, consider decreasing your sample time by one order of magnitude. After such a change, any previously correct I/O driver sample times remain correct, because they are integer multiples of the new application sample time.

S-Functions Using Math Functions

Possible problem — When you create your own S-functions that include math functions, the S-functions compile, but you cannot build the application.

Solution — Add the Real-Time Windows Target header to your S-function. For example, add

```
#include<math.h>
#include"rtwintgt.h"
```

The header `#include<math.h>` must precede the header `#include"rtwintgt.h"`.

Custom I/O Driver Blocks

- “Introduction” on page A-2
- “I/O Register Access from S-Functions Limitation” on page A-3
- “Incompatibility with Win32 API Calls” on page A-4
- “Unsupported C Functions” on page A-5
- “Supported C Functions” on page A-6

Introduction

You can write custom I/O device drivers to work with Real-Time Windows Target applications. We do not recommend using Analog Input, Analog Output, Digital Input, or Digital Output drivers as a starting point for creating custom device drivers.

I/O Register Access from S-Functions Limitation

Windows operating system drivers can access I/O registers only from the real-time kernel and not from the Simulink software. To ensure that drivers do not attempt to access I/O registers from Simulink S-functions, enter code fragments like the following as appropriate:

```
#ifndef MATLAB_MEX_FILE
/* we are in RTWin kernel, safe to do board I/O */
#else
/* we are in Simulink, don't do board I/O */
#endif
```

Incompatibility with Win32 API Calls

The Real-Time Windows Target kernel intercepts the interrupt from the system clock. It then reprograms the system clock to operate at a higher frequency for running your real-time application. At the original clock frequency, it sends an interrupt to the Windows operating system to allow Windows based applications or any software using the Win32 API to run.

As a result, **software that uses the Win32 API cannot be executed as a component of your real-time application.** Any software you use to write I/O drivers must not have any calls to the Win32 API.

Unsupported C Functions

If you create your own custom I/O driver blocks, you should first check for C functions that are supported by Real-Time Windows Target software. Functions that use the Windows operating system are not supported by Real-Time Windows Target software. This is because the kernel intercepts the system clock and first runs the real-time application. If there is time left before the next sample time, the kernel might allow a Windows based application or function to run.

The following list includes many, but not all, of the unsupported functions:

- **File I/O** — `fopen`, `freopen`, `fclose`, `fread`, `fwrite`, `fputs`, `fputc`, `fgets`, `fgetc`, `gets`, `getc`, `getchar`, `puts`, `putc`, `putchar`, `fflush`, `setbuf`, `setvbuf`
- **Console I/O** — `printf`, `fprintf`, `sprintf`, `vfprintf`, `vprintf`, `vsprintf`, `fscanf`, `scanf`, `sscanf`
- **Process management** — `spawn`, `exit`, `abort`, `atexit`
- **Signals and exceptions** — `signal`, `longimp`, `raise`
- **Time functions** — `clock`, `time`, `difftime`, `asctime`, `ctime`, `difftime`, `gmtime`, `localtime`, `mktime`, `strftime`
- **Win32 API functions** — *No Windows API functions are supported.*

Supported C Functions

You can use ANSI C functions that do not use the Windows operating system in your custom blocks or I/O drivers. The following includes a partial list of supported functions:

- **Data conversion** — `abs`, `atof`, `atoi`, `atol`, `itoa`, `labs`, `ltoa`, `strtod`, `strtol`, `strtoul`, `ultoa`
- **Memory allocation** — `calloc`, `free`, `malloc`

Note Memory allocation is not an operation that can be done in real time. To work with a Real-Time Windows Target application, memory management must occur before real-time simulation begins. Simulation switches into real-time after `mdlStart`, so you can allocate memory in `mdlInitializeSizes` or `mdlStart`. You cannot allocate memory in any function after `mdlStart`, such as `mdlOutputs` or `mdlUpdate`.

- **Memory manipulation** — `_memccpy`, `memcpy`, `memchr`, `memcmp`, `_memicmp`, `memmove`, `memset`
- **String manipulation** — `strcat`, `strchr`, `strcmp`, `strcpy`, `strcspn`, `_strdup`, `_stricmp`, `strlen`, `_strlwr`, `strncat`, `strncmp`, `strncpy`, `_strnset`, `strpbrk`, `strrchr`, `_strrev`, `_strset`, `strspn`, `strstr`, `strtok`, `strupr`
- **Mathematical** — `acos`, `asin`, `atan`, `atan2`, `ceil`, `cos`, `cosh`, `div`, `exp`, `fabs`, `floor`, `fmod`, `frexp`, `ldexp`, `ldiv`, `log`, `log10`, `max`, `min`, `modf`, `pow`, `rand`, `sin`, `sinh`, `sqrt`, `srand`, `tan`, `tanh`, `uldiv`
- **Character class tests and conversion** — `isalnum`, `isalpha`, `_isascii`, `isctrl`, `isdigit`, `isgraph`, `islower`, `isprint`, `ispunct`, `isspace`, `isupper`, `isxdigit`, `isxupper`, `isxlower`, `_toascii`, `tolower`, `toupper`
- **Searching and sorting** — `bsearch`, `qsort`
- **Dummy functions** — `exit`, `fprintf`, `printf`

Examples

Use this list to find examples in the documentation.

Simulink Model Examples

- “Specifying the Default Configuration Set” on page 3-7
- “Entering Configuration Parameters Manually” on page 3-8
- “Entering Scope Parameters for Signal Tracing” on page 3-9
- “Running a Simulation” on page 3-12

Real-Time Application Examples

- “Entering Simulation Parameters” on page 3-14
- “Entering Scope Parameters for Signal Tracing” on page 3-17
- “Creating a Real-Time Application” on page 3-19
- “Entering Additional Scope Parameters for Signal Tracing” on page 3-20
- “Running a Real-Time Application” on page 3-23
- “Running an Application from the Command Line” on page 3-25

Signal Logging to MATLAB Workspace Examples

- “Entering Scope Parameters” on page 3-27
- “Entering Signal and Triggering Properties” on page 3-29
- “Plotting Logged Signal Data” on page 3-31

Signal Logging to Disk Drive Examples

- “Entering Scope Parameters” on page 3-34
- “Entering Signal and Triggering Properties” on page 3-37
- “Entering Data Archiving Parameters” on page 3-39
- “Plotting Logged Signal Data” on page 3-41

Parameter Tuning Examples

“Changing Model Parameters” on page 3-45

I/O Board Examples

“Installing and Configuring I/O Boards and Drivers” on page 4-3

“The Real-Time Windows Target Library” on page 4-10

“Output Signals from an I/O Block” on page 4-11

A

- A/D. *See* analog-to-digital
- adding
 - I/O driver blocks 4-10
- analog input
 - normalized scaling 4-17
- analog-to-digital
 - channel selection 4-12
- application
 - Real-Time Windows Target 1-6

C

- capturing and displaying signals 1-2
- changing parameters
 - parameter tuning 1-8
- channel selection
 - entering configurations 4-12
- compact PCI
 - installing 4-8
- compatibility
 - with MathWorks software 1-5
- compiler
 - Open Watcom C/C++ only 1-7
- computer
 - PC-compatible 1-10
- configuring
 - I/O boards and drivers 4-3
- connecting
 - real-time application 3-20
 - Simulink model 3-20
- creating
 - real-time application 3-19
 - Simulink model 1-13
- custom I/O drivers
 - incompatible with Win32 A-4

D

- D/A. *See* digital-to-analog

- data archiving parameters
 - entering 3-39
 - logging data to disk drive 3-39
- data buffers 1-16
- default configuration set 3-7
- demo library
 - opening 2-21
 - Real-Time Windows Target 2-21
- Demux block
 - separating I/O signals 4-11
- description
 - Simulink external mode 1-15
- device drivers
 - channel selection 4-12
 - custom I/O A-1
 - writing custom A-1
- digital-to-analog
 - channel selection 4-12
- directories
 - installed 2-8
 - MATLAB working 2-8
 - project 2-8
 - Real-Time Workshop working 2-8
 - working 2-8
- disk drive
 - plotting logged data 3-41
 - signal logging 3-34

E

- entering
 - data archiving parameters 3-39
 - scope properties 3-34
 - signal and triggering properties 3-37
 - simulation parameters for Real-Time Workshop 3-14
 - simulation parameters for Simulink 3-8
- execution
 - real-time 1-12
 - running in real time 1-13

- external interface MEX-file
 - rtwinext 5-5
 - win_tgt 5-5
- external mode
 - description 1-15
 - parameter tuning 1-8

F

- failure to connect
 - troubleshooting 5-5
- features
 - signal logging 1-7
 - signal tracing 1-7
- files
 - application 2-8
 - external mode interface 2-8
 - I/O drivers 2-8
 - installed 2-8
 - kernel install command 2-8
 - make command 2-8
 - makefile 2-8
 - project directory 2-8
 - Real-Time Windows Target directory 2-8
 - system target 2-8
 - system target file 2-8
 - template makefile 2-8
 - working directory 2-8

H

- hardware
 - system requirements 2-6

I

- I/O blocks
 - input and output 4-10
 - library 4-10
 - separating signals 4-11
- I/O boards

- compact PCI boards 4-8
 - configuring 4-3
 - installing 4-3
- ISA bus 4-7
 - overview 4-3
- PC/104 bus 4-8
- PCI bus 4-7
- PCMCIA 4-9

- I/O drivers
 - characteristics 4-16
 - configuring 4-3
 - installing 4-3
 - using 4-16
- input blocks
 - overview 4-10
- input/output
 - support 1-10
- installing
 - compact PCI 4-8
 - I/O boards 4-3
 - I/O boards and drivers 4-3
 - kernel overview 2-12
 - Real-Time Windows Target 2-8
 - testing installation 2-17

- ISA bus
 - installing 4-7

K

- kernel
 - communication with hardware 1-5
 - installing 2-12
 - scheduler 1-5
 - timer interrupt 1-5
 - uninstalling 2-14

L

- logging
 - data to disk drive 3-34

- data archiving parameters 3-39
- data to workspace 3-27

M

- makefile 2-8
- MathWorks
 - compatible software 1-5
 - Simulink blocks 1-5
- MATLAB workspace
 - signal logging 3-27
- memory management
 - limitation on A-6
- model parameters
 - changing 3-45
 - parameter tuning 3-45

N

- nonreal time
 - simulation 3-12
- normalized scaling
 - analog input 4-17

O

- opening demo library 2-21
- output blocks
 - overview 4-10
- overview
 - I/O boards 4-3
 - input blocks 4-10
 - installing kernel 2-12
 - output blocks 4-10
 - parameter tuning 3-44
 - real-time application 3-14
 - system concepts 1-15
 - system requirements 2-6
 - testing installation 2-17

P

- parameter tuning
 - changing model parameters 3-45
 - changing parameters 1-8
 - external mode 1-8
 - feature 1-8
 - overview 3-44
- PCI bus
 - installing 4-7
- PCMCIA bus
 - installing 4-9
- plots not visible
 - troubleshooting 5-4
- plotting
 - logged data from disk 3-41
 - logged data from workspace 3-31

R

- real-time
 - control 1-2
 - execution 1-12
 - hardware-in-the-loop 1-2
 - signal processing 1-2
- real-time application
 - and the development process 1-13
 - connecting to Simulink model 3-20
 - creating 3-19
 - overview 3-14
 - Real-Time Windows Target 1-6
 - Real-Time Workshop parameters 3-14
 - scope properties for signal tracing 3-17
 - simulation parameters for Real-Time Workshop 3-14
 - software environment 1-6
 - starting 3-23
 - stopping 3-23
- real-time kernel
 - Real-Time Windows Target 1-5
 - scheduler 1-5

- software environment 1-5
- timer interrupt 1-5
- Real-Time Windows Target
 - application 1-6
 - custom I/O device drivers A-1
 - demo library 2-21
 - development process 1-13
 - files 2-8
 - installing kernel 2-12
 - overview 1-2
 - real-time application 1-6
 - real-time kernel 1-5
 - software environment 1-12
 - uninstalling kernel 2-14
- Real-Time Windows Target Library
 - I/O blocks 4-10
- Real-Time Workshop
 - entering simulation parameters 3-14
- requirements
 - hardware 2-6
 - software 2-6
- rtvdp.mdl
 - Simulink model 2-17
- RTWin configuration set 3-7
- rtwinext
 - external interface MEX-file 5-5
- running
 - execution in real time 1-13
 - real-time application 3-23
 - simulation in nonreal time 3-12

S

- S-functions
 - C-code supported in 2-2
 - limitation on I/O register access A-3
 - limitation on memory management A-6
 - M-code not supported in 2-2
 - using math functions in 5-7
 - Win32 calls not usable in 1-5
- sample rates
 - excessive 2-20
- scope output
 - delayed or missing 5-6
- scope properties
 - entering 3-34
 - entering for signal tracing 3-17
 - for signal logging to disk drive 3-34
 - for signal logging to workspace 3-27
- separating
 - I/O signals 4-11
- setting
 - initial working directory 2-10
 - working directory
 - from MATLAB 2-10
 - from the Desktop icon 2-10
- signal and triggering
 - entering properties 3-29
 - properties 3-37
- signal archiving. *See* signal logging
- signal data
 - plotting from disk drive 3-41
 - plotting from workspace 3-31
- signal logging
 - entering scope properties 3-27
 - feature 1-7
 - plotting data 3-31
 - signal and triggering properties 3-37
 - to disk drive 3-34
 - to MATLAB workspace 3-27
- signal logging to disk drive
 - data archiving parameters 3-39
 - signal and triggering properties 3-37
- signal logging to workspace
 - scope properties 3-27
 - signal and triggering properties 3-29
- signal tracing
 - feature 1-7
 - scope properties 3-17
- signals

- capturing and displaying 1-2
- simulation
 - nonreal time 3-12
 - running in nonreal time 1-13
- simulation parameters
 - entering 3-8
 - for Real-Time Workshop 3-14
- Simulink
 - compatibility 2-2
 - compatible software 1-5
 - required product 2-2
 - running a simulation 3-12
- Simulink external mode
 - description 1-15
 - parameter tuning 1-8
- Simulink model
 - and the development process 1-13
 - connect to real-time application 3-20
 - creating 1-13
 - rtvdp.mdl 2-17
- software
 - system requirements 2-6
- software environment
 - overview 1-12
 - real-time application 1-6
 - real-time kernel 1-5
 - requirements 2-6
- starting
 - real-time application 3-23
- stopping
 - real-time application 3-23
- support
 - input/output 1-10
- system concepts
 - data buffers 1-16
 - overview 1-15
 - transferring data 1-16
- system requirements

- hardware 2-6
- overview 2-6
- software 2-6
- software environment 2-6
- system target file 2-8

T

- template makefile 2-8
- testing installation
 - overview 2-17
- transferring data 1-16
- troubleshooting
 - failure to connect 5-5
 - incorrect MEX-file 5-5
 - plots not visible 5-4
 - scope output delayed or missing 5-6

U

- uninstalling
 - kernel 2-14
- using
 - I/O device drivers 4-16

W

- Win32
 - calls not usable in S-functions 1-5
 - incompatible with I/O drivers A-4
- working directory
 - initial 2-10
 - setting
 - from MATLAB 2-10
 - from the Desktop icon 2-10
 - setting initial 2-10
- writing customized device drivers A-1